

ELEVATION CERTIFICATE

IMPORTANT: MUST FOLLOW THE INSTRUCTIONS ON PAGES 1-11

Copy all pages of this Elevation Certificate and all attachments for (1) community official, (2) insurance agent/company, and (3) building owner.

SECTION A – PROPERTY INFORMATION	FOR INSURANCE COMPANY USE
A1. Building Owner's Name: <u>KHASHAYAR & PATRICIA JARA DANESHMAND</u>	Policy Number: _____
A2. Building Street Address (including Apt., Unit, Suite, and/or Bldg. No.) or P.O. Route and Box No.: <u>1109 BAYSHORE ROAD</u>	Company NAIC Number: _____
City: <u>NOKOMIS</u> State: <u>FLORIDA</u> ZIP Code: <u>34275</u>	
A3. Property Description (e.g., Lot and Block Numbers or Legal Description) and/or Tax Parcel Number: <u>METES & BOUNDS, TAX ID #0167160011</u>	
A4. Building Use (e.g., Residential, Non-Residential, Addition, Accessory, etc.): <u>RESIDENTIAL</u>	
A5. Latitude/Longitude: Lat. <u>27.138734°</u> Long. <u>-82.468173°</u> Horizontal Datum: <input type="checkbox"/> NAD 1927 <input checked="" type="checkbox"/> NAD 1983 <input type="checkbox"/> WGS 84	
A6. Attach at least two and when possible four clear photographs (one for each side) of the building (see Form pages 7 and 8).	
A7. Building Diagram Number: <u>1B</u>	
A8. For a building with a crawlspace or enclosure(s):	
a) Square footage of crawlspace or enclosure(s): <u>N/A</u> sq. ft.	
b) Is there at least one permanent flood opening on two different sides of each enclosed area? <input type="checkbox"/> Yes <input type="checkbox"/> No <input checked="" type="checkbox"/> N/A	
c) Enter number of permanent flood openings in the crawlspace or enclosure(s) within 1.0 foot above adjacent grade: Non-engineered flood openings: <u>N/A</u> Engineered flood openings: <u>N/A</u>	
d) Total net open area of non-engineered flood openings in A8.c: <u>N/A</u> sq. in.	
e) Total rated area of engineered flood openings in A8.c (attach documentation – see Instructions): <u>N/A</u> sq. ft.	
f) Sum of A8.d and A8.e rated area (if applicable – see Instructions): <u>N/A</u> sq. ft.	
A9. For a building with an attached garage:	
a) Square footage of attached garage: <u>823</u> sq. ft.	
b) Is there at least one permanent flood opening on two different sides of the attached garage? <input checked="" type="checkbox"/> Yes <input type="checkbox"/> No <input type="checkbox"/> N/A	
c) Enter number of permanent flood openings in the attached garage within 1.0 foot above adjacent grade: Non-engineered flood openings: <u>N/A</u> Engineered flood openings: <u>5</u>	
d) Total net open area of non-engineered flood openings in A9.c: <u>N/A</u> sq. in.	
e) Total rated area of engineered flood openings in A9.c (attach documentation – see Instructions): <u>1100</u> sq. ft.	
f) Sum of A9.d and A9.e rated area (if applicable – see Instructions): <u>N/A</u> sq. ft.	

SECTION B – FLOOD INSURANCE RATE MAP (FIRM) INFORMATION

B1.a. NFIP Community Name: <u>SARASOTA COUNTY</u>	B1.b. NFIP Community Identification Number: <u>125144</u>
B2. County Name: <u>SARASOTA</u>	B3. State: <u>FL</u>
B4. Map/Panel No.: <u>12115C-0239</u>	B5. Suffix: <u>G</u>
B6. FIRM Index Date: <u>03/27/2024</u>	B7. FIRM Panel Effective/Revised Date: <u>03/27/2024</u>
B8. Flood Zone(s): <u>AE & X</u>	B9. Base Flood Elevation(s) (BFE) (Zone AO, use Base Flood Depth): <u>7' & N/A</u>
B10. Indicate the source of the BFE data or Base Flood Depth entered in Item B9: <input type="checkbox"/> FIS <input checked="" type="checkbox"/> FIRM <input type="checkbox"/> Community Determined <input type="checkbox"/> Other: _____	
B11. Indicate elevation datum used for BFE in Item B9: <input type="checkbox"/> NGVD 1929 <input checked="" type="checkbox"/> NAVD 1988 <input type="checkbox"/> Other/Source: _____	
B12. Is the building located in a Coastal Barrier Resources System (CBRS) area or Otherwise Protected Area (OPA)? <input type="checkbox"/> Yes <input checked="" type="checkbox"/> No Designation Date: <u>N/A</u> <input type="checkbox"/> CBRS <input type="checkbox"/> OPA	
B13. Is the building located seaward of the Limit of Moderate Wave Action (LiMWA)? <input type="checkbox"/> Yes <input checked="" type="checkbox"/> No	

ELEVATION CERTIFICATE

IMPORTANT: MUST FOLLOW THE INSTRUCTIONS ON PAGES 1-11

Building Street Address (including Apt., Unit, Suite, and/or Bldg. No.) or P.O. Route and Box No.: <u>1109 BAYSHORE ROAD</u>	FOR INSURANCE COMPANY USE
City: <u>NOKOMIS</u> State: <u>FLORIDA</u> ZIP Code: <u>34275</u>	Policy Number: _____ Company NAIC Number: _____

SECTION C – BUILDING ELEVATION INFORMATION (SURVEY REQUIRED)

- C1. Building elevations are based on: Construction Drawings* Building Under Construction* Finished Construction
 *A new Elevation Certificate will be required when construction of the building is complete.
- C2. Elevations – Zones A1–A30, AE, AH, AO, A (with BFE), VE, V1–V30, V (with BFE), AR, AR/A, AR/AE, AR/A1–A30, AR/AH, AR/AO, A99. Complete Items C2.a–h below according to the Building Diagram specified in Item A7. In Puerto Rico only, enter meters.
 Benchmark Utilized: PLAT BM 167 EL: 5.95' Vertical Datum: NGVD1929

Indicate elevation datum used for the elevations in items a) through h) below.

NGVD 1929 NAVD 1988 Other: _____

Datum used for building elevations must be the same as that used for the BFE. Conversion factor used? Yes No

If Yes, describe the source of the conversion factor in the Section D Comments area.

Check the measurement used:

- | | | | |
|---|-------------|--|--|
| a) Top of bottom floor (including basement, crawlspace, or enclosure floor): | <u>12.5</u> | | <input checked="" type="checkbox"/> feet <input type="checkbox"/> meters |
| b) Top of the next higher floor (see Instructions): | <u>26.0</u> | | <input checked="" type="checkbox"/> feet <input type="checkbox"/> meters |
| c) Bottom of the lowest horizontal structural member (see Instructions): | <u>N/A</u> | | <input checked="" type="checkbox"/> feet <input type="checkbox"/> meters |
| d) Attached garage (top of slab): | <u>9.9</u> | | <input checked="" type="checkbox"/> feet <input type="checkbox"/> meters |
| e) Lowest elevation of Machinery and Equipment (M&E) servicing the building (describe type of M&E and location in Section D Comments area): | <u>12.0</u> | | <input checked="" type="checkbox"/> feet <input type="checkbox"/> meters |
| f) Lowest Adjacent Grade (LAG) next to building: <input type="checkbox"/> Natural <input checked="" type="checkbox"/> Finished | <u>6.2</u> | | <input checked="" type="checkbox"/> feet <input type="checkbox"/> meters |
| g) Highest Adjacent Grade (HAG) next to building: <input type="checkbox"/> Natural <input checked="" type="checkbox"/> Finished | <u>9.1</u> | | <input checked="" type="checkbox"/> feet <input type="checkbox"/> meters |
| h) Finished LAG at lowest elevation of attached deck or stairs, including structural support: | <u>4.2</u> | | <input checked="" type="checkbox"/> feet <input type="checkbox"/> meters |

SECTION D – SURVEYOR, ENGINEER, OR ARCHITECT CERTIFICATION

This certification is to be signed and sealed by a land surveyor, engineer, or architect authorized by state law to certify elevation information. I certify that the information on this Certificate represents my best efforts to interpret the data available. I understand that any false statement may be punishable by fine or imprisonment under 18 U.S. Code, Section 1001.

Were latitude and longitude in Section A provided by a licensed land surveyor? Yes No

Check here if attachments and describe in the Comments area.

Certifier's Name: B. GREGORY RIETH, PSM, CFM License Number: 5228

Title: VICE PRESIDENT

Company Name: BENNETT-PANFIL, INC.

Address: 742 SHAMROCK BLVD

City: VENICE State: Florida ZIP Code: 34293

Signature:  Date: 06/10/2024

Telephone: (941) 497-1290 Ext.: _____ Email: INFO@BPISURVEY.COM



Copy all pages of this Elevation Certificate and all attachments for (1) community official, (2) insurance agent/company, and (3) building owner.

Comments (including source of conversion factor in C2; type of equipment and location per C2.e; and description of any attachments):

(File #21-09-63)

[Section A5] Derived from a hand held G.P.S. unit (GPSTEST App - No Conversion). [Section A9] Engineered openings manufactured by Flood Flaps model number FFWF08, ICC-ES Report No. ESR-3560 (attached). [Section C] Elevations were converted from N.G.V.D. 1929 to N.A.V.D. 1988 using Corpscon Version 6.0.1. conversion factor of -1.06'. Flood zone at the time of Original Survey "AE" (10' & 11') 12115C-0239F, 11/04/2016. [Section C2e] Is the bottom of the air conditioning unit located on the south side of the building.

Date of Field Survey: 06/04/2024

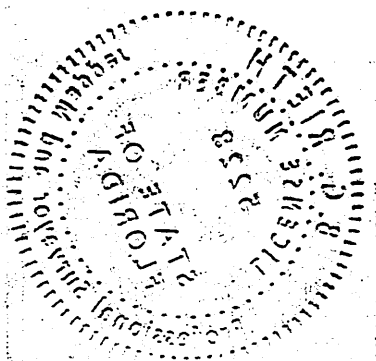

1968

ELEVATION CERTIFICATE

IMPORTANT: MUST FOLLOW THE INSTRUCTIONS ON PAGES 1-11

Building Street Address (including Apt., Unit, Suite, and/or Bldg. No.) or P.O. Route and Box No.:
1109 BAYSHORE ROAD

City: NOKOMIS State: FLORIDA ZIP Code: 34275

FOR INSURANCE COMPANY USE

Policy Number: _____

Company NAIC Number: _____

**SECTION E – BUILDING MEASUREMENT INFORMATION (SURVEY NOT REQUIRED)
FOR ZONE AO, ZONE AR/AO, AND ZONE A (WITHOUT BFE)**

For Zones AO, AR/AO, and A (without BFE), complete Items E1–E5. For Items E1–E4, use natural grade, if available. If the Certificate is intended to support a Letter of Map Change request, complete Sections A, B, and C. Check the measurement used. In Puerto Rico only, enter meters.

Building measurements are based on: Construction Drawings* Building Under Construction* Finished Construction

*A new Elevation Certificate will be required when construction of the building is complete.

E1. Provide measurements (C.2.a in applicable Building Diagram) for the following and check the appropriate boxes to show whether the measurement is above or below the natural HAG and the LAG.

a) Top of bottom floor (including basement, crawlspace, or enclosure) is: _____ feet meters above or below the HAG.

b) Top of bottom floor (including basement, crawlspace, or enclosure) is: _____ feet meters above or below the LAG.

E2. For Building Diagrams 6–9 with permanent flood openings provided in Section A Items 8 and/or 9 (see pages 1–2 of Instructions), the next higher floor (C2.b in applicable Building Diagram) of the building is: _____ feet meters above or below the HAG.

E3. Attached garage (top of slab) is: _____ feet meters above or below the HAG.

E4. Top of platform of machinery and/or equipment servicing the building is: _____ feet meters above or below the HAG.

E5. Zone AO only: If no flood depth number is available, is the top of the bottom floor elevated in accordance with the community's floodplain management ordinance? Yes No Unknown The local official must certify this information in Section G.

SECTION F – PROPERTY OWNER (OR OWNER'S AUTHORIZED REPRESENTATIVE) CERTIFICATION

The property owner or owner's authorized representative who completes Sections A, B, and E for Zone A (without BFE) or Zone AO must sign here. *The statements in Sections A, B, and E are correct to the best of my knowledge*

Check here if attachments and describe in the Comments area.

Property Owner or Owner's Authorized Representative Name: _____

Address: _____

City: _____ State: _____ ZIP Code: _____

Signature: _____ Date: _____

Telephone: _____ Ext.: _____ Email: _____

Comments: _____

ELEVATION CERTIFICATE

IMPORTANT: MUST FOLLOW THE INSTRUCTIONS ON PAGES 1-11

Building Street Address (including Apt., Unit, Suite, and/or Bldg. No.) or P.O. Route and Box No.:
1109 BAYSHORE ROAD

FOR INSURANCE COMPANY USE

City: NOKOMIS State: FLORIDA ZIP Code: 34275

Policy Number: _____

Company NAIC Number: _____

SECTION G – COMMUNITY INFORMATION (RECOMMENDED FOR COMMUNITY OFFICIAL COMPLETION)

The local official who is authorized by law or ordinance to administer the community's floodplain management ordinance can complete Section A, B, C, E, G, or H of this Elevation Certificate. Complete the applicable item(s) and sign below when:

- G1. The information in Section C was taken from other documentation that has been signed and sealed by a licensed surveyor, engineer, or architect who is authorized by state law to certify elevation information. (Indicate the source and date of the elevation data in the Comments area below.)
- G2.a. A local official completed Section E for a building located in Zone A (without a BFE), Zone AO, or Zone AR/AO, or when item E5 is completed for a building located in Zone AO.
- G2.b. A local official completed Section H for insurance purposes.
- G3. In the Comments area of Section G, the local official describes specific corrections to the information in Sections A, B, E and H.
- G4. The following information (Items G5–G11) is provided for community floodplain management purposes.

G5. Permit Number: 21186699 B1 G6. Date Permit Issued: 6/13/2022

G7. Date Certificate of Compliance/Occupancy Issued: _____

G8. This permit has been issued for: New Construction Substantial Improvement

G9.a. Elevation of as-built lowest floor (including basement) of the building: _____ feet meters Datum: _____

G9.b. Elevation of bottom of as-built lowest horizontal structural member: _____ feet meters Datum: _____

G10.a. BFE (or depth in Zone AO) of flooding at the building site: _____ feet meters Datum: _____

G10.b. Community's minimum elevation (or depth in Zone AO) requirement for the lowest floor or lowest horizontal structural member: _____ feet meters Datum: _____

G11. Variance issued? Yes No If yes, attach documentation and describe in the Comments area.

The local official who provides information in Section G must sign here. *I have completed the information in Section G and certify that it is correct to the best of my knowledge. If applicable, I have also provided specific corrections in the Comments area of this section.*

Local Official's Name: Ember Dunn Title: _____

NFIP Community Name: _____

Telephone: _____ Ext.: _____ Email: _____

Address: _____

City: _____ State: _____ ZIP Code: _____

Signature:  Date: 8/8/2024

Comments (including type of equipment and location, per C2.e; description of any attachments; and corrections to specific information in Sections A, B, D, E, or H):

ELEVATION CERTIFICATE

IMPORTANT: MUST FOLLOW THE INSTRUCTIONS ON PAGES 1-11

Building Street Address (including Apt., Unit, Suite, and/or Bldg. No.) or P.O. Route and Box No.: 1109 BAYSHORE ROAD	FOR INSURANCE COMPANY USE
City: NOKOMIS State: FLORIDA ZIP Code: 34275	Policy Number: _____ Company NAIC Number: _____

**SECTION H – BUILDING'S FIRST FLOOR HEIGHT INFORMATION FOR ALL ZONES
(SURVEY NOT REQUIRED) (FOR INSURANCE PURPOSES ONLY)**

The property owner, owner's authorized representative, or local floodplain management official may complete Section H for all flood zones to determine the building's first floor height for insurance purposes. Sections A, B, and I must also be completed. Enter heights to the nearest tenth of a foot (nearest tenth of a meter in Puerto Rico). **Reference the Foundation Type Diagrams (at the end of Section H Instructions) and the appropriate Building Diagrams (at the end of Section I Instructions) to complete this section.**

- H1. Provide the height of the top of the floor (as indicated in Foundation Type Diagrams) above the Lowest Adjacent Grade (LAG):
- a) **For Building Diagrams 1A, 1B, 3, and 5–9.** Top of bottom _____ feet meters above the LAG floor (include above-grade floors only for buildings with subgrade crawlspaces or enclosure floors) is:
 - b) **For Building Diagrams 2A, 2B, 4, and 6–9.** Top of next _____ feet meters above the LAG higher floor (i.e., the floor above basement, crawlspace, or enclosure floor) is:
- H2. Is **all** Machinery and Equipment servicing the building (as listed in Item H2 instructions) elevated to or above the floor indicated by the H2 arrow (shown in the Foundation Type Diagrams at end of Section H instructions) for the appropriate Building Diagram?
 Yes No

SECTION I – PROPERTY OWNER (OR OWNER'S AUTHORIZED REPRESENTATIVE) CERTIFICATION

The property owner or owner's authorized representative who completes Sections A, B, and H must sign here. *The statements in Sections A, B, and H are correct to the best of my knowledge.* **Note:** If the local floodplain management official completed Section H, they should indicate in Item G2.b and sign Section G.

Check here if attachments are provided (including required photos) and describe each attachment in the Comments area.

Property Owner or Owner's Authorized Representative Name: _____

Address: _____

City: _____ State: _____ ZIP Code: _____

Signature: _____ Date: _____

Telephone: _____ Ext.: _____ Email: _____

Comments:

ELEVATION CERTIFICATE

IMPORTANT: MUST FOLLOW THE INSTRUCTIONS ON PAGES 1-11
BUILDING PHOTOGRAPHS

See Instructions for Item A6.

Building Street Address (including Apt., Unit, Suite, and/or Bldg. No.) or P.O. Route and Box No.:
1109 BAYSHORE ROAD

City: NOKOMIS State: FLORIDA ZIP Code: 34275

FOR INSURANCE COMPANY USE

Policy Number: _____

Company NAIC Number: _____

Instructions: Insert below at least two and when possible four photographs showing each side of the building (for example, may only be able to take front and back pictures of townhouses/rowhouses). Identify all photographs with the date taken and "Front View," "Rear View," "Right Side View," or "Left Side View." Photographs must show the foundation. When flood openings are present, include at least one close-up photograph of representative flood openings or vents, as indicated in Sections A8 and A9.



Photo One

Photo One Caption: [FRONT VIEW; PHOTO TAKEN 06/04/2024]

Clear Photo One

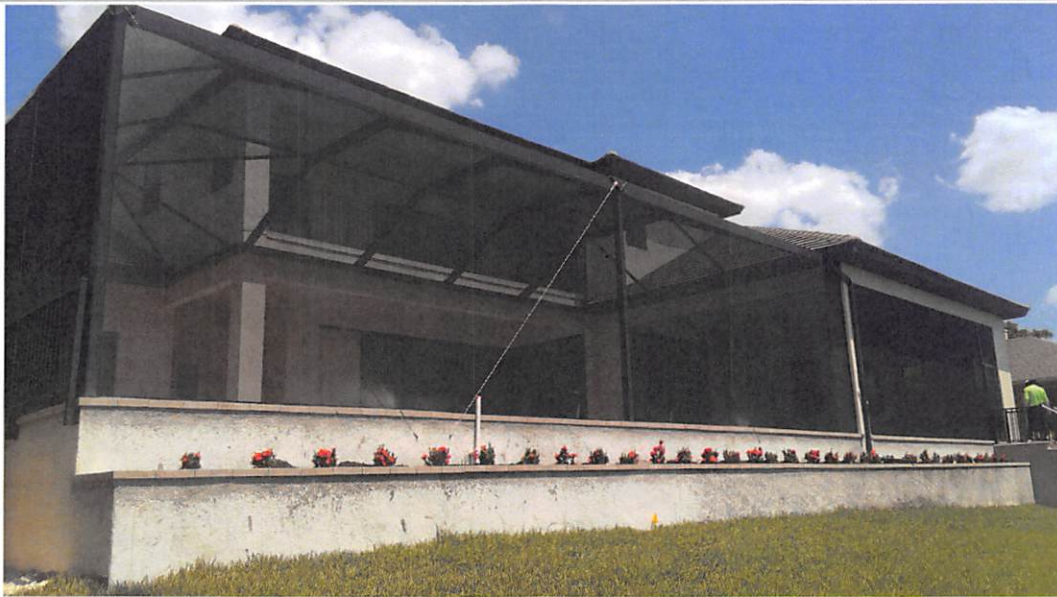

Photo Two

Photo Two Caption: [REAR VIEW; PHOTO TAKEN 06/04/2024]

Clear Photo Two

ELEVATION CERTIFICATE
IMPORTANT: MUST FOLLOW THE INSTRUCTIONS ON PAGES 1-11
BUILDING PHOTOGRAPHS

Continuation Page

Building Street Address (including Apt., Unit, Suite, and/or Bldg. No.) or P.O. Route and Box No.:
1109 BAYSHORE ROAD

City: NOKOMIS State: FLORIDA ZIP Code: 34275

FOR INSURANCE COMPANY USE

Policy Number: _____

Company NAIC Number: _____

Insert the third and fourth photographs below. Identify all photographs with the date taken and "Front View," "Rear View," "Right Side View," or "Left Side View." When flood openings are present, include at least one close-up photograph of representative flood openings or vents, as indicated in Sections A8 and A9.



Photo Three

Photo Three Caption: [SIDE VIEW; PHOTO TAKEN 06/04/2024]

Clear Photo Three



Photo Four

Photo Four Caption: [VENTS; PHOTO TAKEN 06/04/2024]

Clear Photo Four

ICC-ES Evaluation Report

ESR-3560

Reissued September 2023

This report also contains:

- CBC Supplement

Subject to renewal September 2024

- FBC Supplement

ICC-ES Evaluation Reports are not to be construed as representing aesthetics or any other attributes not specifically addressed, nor are they to be construed as an endorsement of the subject of the report or a recommendation for its use. There is no warranty by ICC Evaluation Service, LLC, express or implied, as to any finding or other matter in this report, or as to any product covered by the report.

Copyright © 2023 ICC Evaluation Service, LLC. All rights reserved.

<p>DIVISION: 08 00 00 - OPENINGS</p> <p>Section: 08 95 43— Vents/Foundation Flood Vents</p>	<p>REPORT HOLDER: FLOOD FLAPS®, LLC</p>	<p>EVALUATION SUBJECT: FLOOD FLAPS® AUTOMATIC FLOOD VENTS: MODELS FFWF12; FFNF12; FFWF08; FFNF08; FFWF05; FFNF05</p>	
---	--	---	---

1.0 EVALUATION SCOPE

Compliance with the following codes:

- 2021, 2018, 2015, 2012 and 2009 [International Building Code® \(IBC\)](#)
- 2021, 2018, 2015, 2012 and 2009 [International Residential Code® \(IRC\)](#)

Properties evaluated:

- Physical operation
- Water flow
- Weathering

2.0 USES

Flood Flaps® automatic flood vents are used to provide for the equalization of hydrostatic flood forces on exterior walls. Certain models also allow natural ventilation.

3.0 DESCRIPTION

3.1 General:

Flood Flaps® automatic flood vents are engineered mechanically operated flood vents (FVs) that automatically allow flood waters to enter and exit enclosed areas. The FVs are constructed of ABS plastic which serves as the FV's housing, and a front grill that contains an anodized metal screen imbedded in polypropylene plastic. On contact with rising flood water, the grill will disengage from its secured position, allowing flood water and debris to flow through in either direction. The FVs are available in two series as described in Section 3.3.

The sealed series models contain two rubber flaps that close the FV to the passage of air when using with conditioned areas or sealed crawl spaces. In the same manner as the grill, the two rubber flaps are pushed open by water pressure, allowing water and debris to flow through the FV in either direction. See [Figure 1](#) for an illustration of the Flood Flaps® automatic FV.

3.2 Engineered Opening:

The Flood Flaps® automatic FVs comply with the design principle noted in Sections 2.7.2.2 and 2.7.3 of ASCE/SEI 24-14 (2021, 2018 and 2015 IBC and IRC) [Section 2.6.2.2 of ASCE/SEI 24-05 (2012 and 2009 IBC and IRC)] for a rate of rise and fall of 5 feet per hour (0.423 mm/s). In order to comply with the engineered

opening requirement of ASCE/SEI 24, Flood Flaps[®] automatic FVs must be installed in accordance with Section 4.0.

3.3 Flood Vent Series Models:

Flood Flaps[®] automatic FVs are available in two series with multiple models and sizes as described in [Table 1](#). The sealed series models, designated FFWF, include two rubber flaps for the prevention of air flow. The multi-purpose series, designated FFNF, omits the rubber flaps.

3.4 Natural Ventilation:

Flood Flaps[®] automatic FV models FFNF12, FFNF08, FFNF05, and FFNF02 have metal screens with 1/4 inch by 1/4-inch (6 mm by 6 mm) openings and provide 37 square inches (0.02 m²) of net free opening to supply natural ventilation for under-floor ventilation. Flood Flaps[®] automatic FV models FFWF12, FFWF08, and FFWF05 have not been evaluated for use as openings for under-floor ventilation.

4.0 DESIGN AND INSTALLATION

Flood Flaps[®] automatic FVs are designed to be installed into walls of existing or new construction. Installation of the FVs must be in accordance with the manufacturer's instructions, the applicable code and this report. Flood Flaps[®] automatic FVs can be installed in wood, masonry and concrete walls up to a thickness of 12 inches (305 mm). In order to comply with the engineered opening design principle noted in Sections 2.7.2.2 and 2.7.3 of ASCE/SEI 24-14 (2021, 2018 and 2015 IBC and IRC) [Section 2.6.2.2 of ASCE/SEI 24-05 (2012 and 2009 IBC and IRC)], the Flood Flaps[®] FVs must be installed as follows:

- With a minimum of two openings on different sides of each enclosed area.
- With a minimum of one FV for every 220 squarefeet (20 m²) of enclosed area.
- Below the base flood elevation.
- With the bottom of the FV located a maximum of 12 inches (305 mm) above grade.

5.0 CONDITIONS OF USE:

The Flood Flaps[®] automatic flood vents described in this report comply with, or are suitable alternatives to what is specified in, those codes listed in Section 1.0 of this report, subject to the following conditions:

- 5.1 The Flood Flaps[®] automatic FVs must be installed in accordance with this report, the applicable code and the manufacturer's installation instructions. In the event of a conflict, the instructions in this report govern.
- 5.2 The Flood Flaps[®] automatic FVs must not be used in place of "breakaway walls" in coastal high hazard areas but are permitted for use in conjunction with breakaway walls in other areas.

6.0 EVIDENCE SUBMITTED

Data in accordance with the [ICC-ES Acceptance Criteria for Mechanically Operated Flood Vents \(AC364\)](#), dated August 2015 (editorially revised April 2021).

7.0 IDENTIFICATION

- 7.1 The ICC-ES mark of conformity, electronic labeling, or the evaluation report number (ICC-ES ESR-3560) along with the name, registered trademark, or registered logo of the report holder (Flood Flaps[®]) must be included in the product label.
- 7.2 In addition, the Flood Flaps[®] models described in this report are identified by a label bearing the model number.
- 7.3 The report holder's contact information is the following:

FLOOD FLAPS[®], LLC
POST OFFICE BOX 1003
ISLE OF PALMS, SOUTH CAROLINA 29451
(843) 881-0190
www.floodflaps.com
info@floodflaps.com

TABLE 1—FLOOD FLAP AUTOMATIC FLOOD VENT MODEL SIZES

MODEL NUMBER	MODEL DESIGNATION	ROUGH OPENING (Width X Height) (inches)	VENT SIZE (W X H X D) (inches)	ENCLOSED AREA COVERAGE ² (ft ²)	NET FREE AREA OPENING ¹ (in ²)
FFWF12	Sealed Series	16 x 8	15 ⁵ / ₈ X 7 ³ / ₄ X 12	220	NA
FFNF12	Multi-Purpose	16 x 8	15 ⁵ / ₈ X 7 ³ / ₄ X 12	220	37
FFWF08	Sealed Series	16 x 8	15 ⁵ / ₈ X 7 ³ / ₄ X 8	220	NA
FFNF08	Multi-Purpose	16 x 8	15 ⁵ / ₈ X 7 ³ / ₄ X 8	220	37
FFWF05	Sealed Series	16 x 8	15 ⁵ / ₈ X 7 ³ / ₄ X 5	220	NA
FFNF05	Multi-Purpose	16 x 8	15 ⁵ / ₈ X 7 ³ / ₄ X 5	220	37

For SI: 1 inch = 25.4 mm; 1 ft² = 0.093 m²

¹For under-floor ventilation only.

²The enclosed coverage area in square feet for each model is equivalent to the performance of the same number of square inches of non-engineered openings.

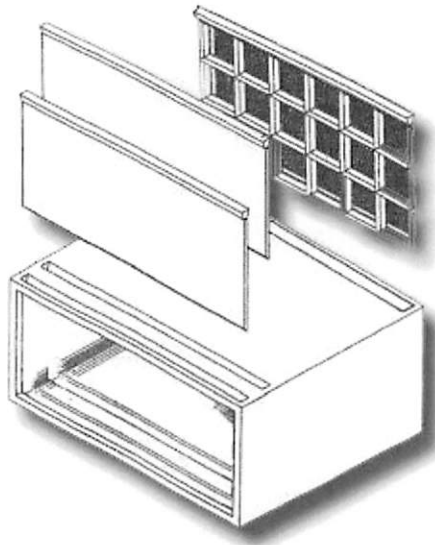
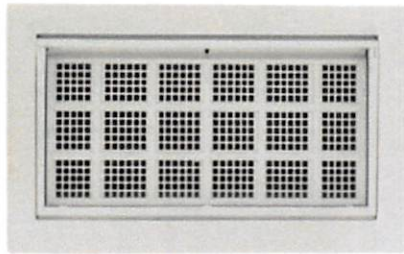
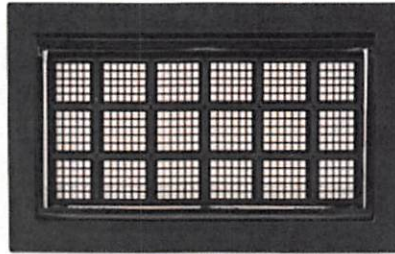

FIGURE 1—FLOOD FLAPS[®] AUTOMATIC FLOOD VENT



FFWF12



FFNF08

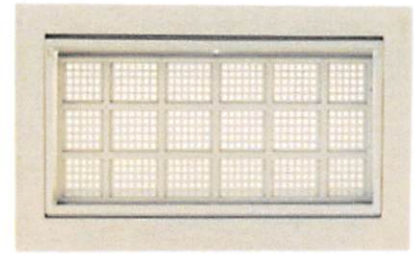

FFNF05

FIGURE 2—FLOOD FLAPS® AUTOMATIC FLOOD VENT SERIES MODELS



12" DEPTH

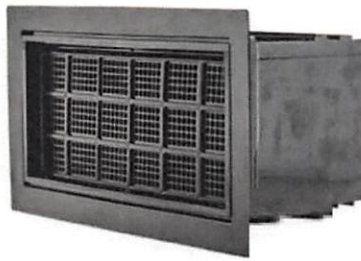

8" DEPTH

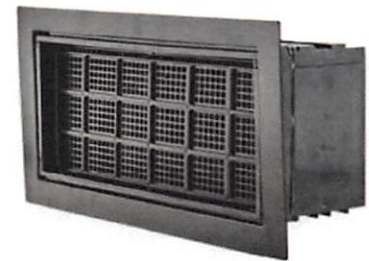

5" DEPTH

FIGURE 3—FLOOD FLAPS® AUTOMATIC FLOOD VENTS MULTIPLE DEPTH OFFERINGS

DIVISION: 08 00 00—OPENINGS

Section: 08 95 43—Vents/Foundation Flood Vents

REPORT HOLDER:

FLOOD FLAPS®, LLC

EVALUATION SUBJECT:

FLOOD FLAPS® AUTOMATIC FLOOD VENTS: MODELS FFWF12; FFNF12; FFWF08; FFNF08; FFWF05; FFNF05

1.0 REPORT PURPOSE AND SCOPE

Purpose:

The purpose of this evaluation report supplement is to indicate that Flood Flaps® automatic flood vents, described in ICC-ES evaluation report ESR-3560, has also been evaluated for compliance with the code(s) noted below.

Applicable code editions:

- 2022 California Building Code (CBC)
- 2022 California Residential Code (CRC)

For evaluation of applicable Chapters adopted by the California Office of Statewide Health Planning and Development (OSHPD) AKA: California Department of Health Care Access and Information (HCAI) and the Division of State Architect (DSA), see Sections 2.1.1 and 2.1.2 below.

2.0 CONCLUSIONS

2.1 CBC:

The Flood Flaps® automatic flood vents, described in Sections 2.0 through 7.0 of the evaluation report ESR-3560, comply with CBC Chapter 12, provided the design and installation are in accordance with the 2021 *International Building Code*® (IBC) provisions noted in the evaluation report and the additional requirements of CBC Chapters 12 and 16, as applicable.

2.1.1 OSHPD: The applicable OSHPD Sections and Chapters of the CBC are beyond the scope of this supplement.

2.1.2 DSA: The applicable DSA Sections and Chapters of the CBC are beyond the scope of this supplement.

2.2 CRC:

The Flood Flaps® automatic flood vents, described in Sections 2.0 through 7.0 of the evaluation report ESR-3560, comply with 2021 CRC, provided the design and installation are in accordance with the 2021 *International Residential Code*® (IRC) provisions noted in the evaluation report.

This supplement expires concurrently with the evaluation report, reissued September 2023.

DIVISION: 08 00 00—OPENINGS**Section: 08 95 43—Vents/Foundation Flood Vents****REPORT HOLDER:**

FLOOD FLAPS®, LLC

EVALUATION SUBJECT:

FLOOD FLAPS® AUTOMATIC FLOOD VENTS: MODELS FFWF12; FFNF12; FFWF08; FFNF08; FFWF05; FFNF05

1.0 REPORT PURPOSE AND SCOPE**Purpose:**

The purpose of this evaluation report supplement is to indicate that Flood Flaps® automatic flood vents, described in ICC-ES evaluation report ESR-3560, have also been evaluated for compliance with the codes noted below.

Applicable code editions:

- 2023 and 2020 *Florida Building Code—Building*
- 2023 and 2020 *Florida Building Code—Residential*

2.0 CONCLUSIONS

The Flood Flaps® flood vents, described in Sections 2.0 through 7.0 of the evaluation report ESR-3560, comply with the *Florida Building Code—Building* and the *Florida Building Code—Residential*, provided the design requirements are determined in accordance with the *Florida Building Code—Building* or the *Florida Building Code—Residential*, as applicable. The installation requirements noted in ICC-ES evaluation report ESR-3530 for the 2021 and 2018 *International Building Code*® meet the requirements of the *Florida Building Code—Building* or the *Florida Building Code—Residential*, as applicable.

Use of the Flood Flaps flood vents has also been found to be in compliance with the High-Velocity Hurricane Zone provisions of the *Florida Building Code—Building* and the *Florida Building Code—Residential*.

For products falling under Florida Rule 61G20-3, verification that the report holder's quality-assurance program is audited by a quality-assurance entity approved by the Florida Building Commission for the type of inspections being conducted is the responsibility of an approved validation entity (or the code official, when the report holder does not possess an approval by the Commission).

This supplement expires concurrently with the evaluation report, reissued September 2023.