

# ELEVATION CERTIFICATE

OMB No. 1660-0008  
Expiration Date: November 30, 2022

<b>IMPORTANT: In these spaces, copy the corresponding information from Section A.</b>			<b>FOR INSURANCE COMPANY USE</b>		
Building Street Address (including Apt., Unit, Suite, and/or Bldg. No.) or P.O. Route and Box No. 2807 LEMON AVENUE			Policy Number:		
City ENGLEWOOD	State Florida	ZIP Code 34223	Company NAIC Number		
<b>SECTION G – COMMUNITY INFORMATION (OPTIONAL)</b>					
The local official who is authorized by law or ordinance to administer the community's floodplain management ordinance can complete Sections A, B, C (or E), and G of this Elevation Certificate. Complete the applicable item(s) and sign below. Check the measurement used in Items G8–G10. In Puerto Rico only, enter meters.					
<p>G1. <input type="checkbox"/> The information in Section C was taken from other documentation that has been signed and sealed by a licensed surveyor, engineer, or architect who is authorized by law to certify elevation information. (Indicate the source and date of the elevation data in the Comments area below.)</p> <p>G2. <input type="checkbox"/> A community official completed Section E for a building located in Zone A (without a FEMA-issued or community-issued BFE) or Zone AO.</p> <p>G3. <input type="checkbox"/> The following information (Items G4–G10) is provided for community floodplain management purposes.</p>					
G4. Permit Number <span style="font-size: 1.2em; color: blue;">20-109074 B1</span>		G5. Date Permit Issued		G6. Date Certificate of Compliance/Occupancy Issued	
<p>G7. This permit has been issued for:     <input checked="" type="checkbox"/> New Construction    <input type="checkbox"/> Substantial Improvement</p> <p>G8. Elevation of as-built lowest floor (including basement) of the building: _____    <input type="checkbox"/> feet    <input type="checkbox"/> meters    Datum _____</p> <p>G9. BFE or (in Zone AO) depth of flooding at the building site: _____    <input type="checkbox"/> feet    <input type="checkbox"/> meters    Datum _____</p> <p>G10. Community's design flood elevation: _____    <input type="checkbox"/> feet    <input type="checkbox"/> meters    Datum _____</p>					
Local Official's Name			Title		
Community Name			Telephone		
Signature			Date		
Comments (including type of equipment and location, per C2(e), if applicable)					
<input type="checkbox"/> Check here if attachments.					

# ELEVATION CERTIFICATE

Important: Follow the instructions on pages 1-9.

Copy all pages of this Elevation Certificate and all attachments for (1) community official, (2) insurance agent/company, and (3) building owner.

SECTION A - PROPERTY INFORMATION						FOR INSURANCE COMPANY USE
A1. Building Owner's Name ZUERICH INC					Policy Number:	
A2. Building Street Address (including Apt., Unit, Suite, and/or Bldg. No.) or P.O. Route and Box No. 2807 LEMON AVENUE					Company NAIC Number:	
City ENGLEWOOD		State Florida		ZIP Code 34223		
A3. Property Description (Lot and Block Numbers, Tax Parcel Number, Legal Description, etc.) LOT 10, BLOCK 6, MANASOTA LAND & TIMBER CO, TAX ID #0475030029						
A4. Building Use (e.g., Residential, Non-Residential, Addition, Accessory, etc.) <u>RESIDENTIAL</u>						
A5. Latitude/Longitude: Lat. <u>27.01949°</u> Long. <u>-82.41314°</u> Horizontal Datum: <input type="checkbox"/> NAD 1927 <input checked="" type="checkbox"/> NAD 1983						
A6. Attach at least 2 photographs of the building if the Certificate is being used to obtain flood insurance.						
A7. Building Diagram Number <u>7</u>						
A8. For a building with a crawlspace or enclosure(s):						
a) Square footage of crawlspace or enclosure(s) <u>1,672</u> sq ft						
b) Number of permanent flood openings in the crawlspace or enclosure(s) within 1.0 foot above adjacent grade <u>11</u>						
c) Total net area of flood openings in A8.b <u>2,200</u> sq in						
d) Engineered flood openings? <input checked="" type="checkbox"/> Yes <input type="checkbox"/> No						
A9. For a building with an attached garage:						
a) Square footage of attached garage <u>0</u> sq ft						
b) Number of permanent flood openings in the attached garage within 1.0 foot above adjacent grade <u>0</u>						
c) Total net area of flood openings in A9.b <u>0</u> sq in						
d) Engineered flood openings? <input type="checkbox"/> Yes <input checked="" type="checkbox"/> No						
SECTION B - FLOOD INSURANCE RATE MAP (FIRM) INFORMATION						
B1. NFIP Community Name & Community Number SARASOTA COUNTY - 125144			B2. County Name SARASOTA		B3. State Florida	
B4. Map/Panel Number 12115C-0343	B5. Suffix F	B6. FIRM Index Date 11-04-2016	B7. FIRM Panel Effective/ Revised Date 11-04-2016	B8. Flood Zone(s) AE	B9. Base Flood Elevation(s) (Zone AO, use Base Flood Depth) 11'	
B10. Indicate the source of the Base Flood Elevation (BFE) data or base flood depth entered in Item B9: <input type="checkbox"/> FIS Profile <input checked="" type="checkbox"/> FIRM <input type="checkbox"/> Community Determined <input type="checkbox"/> Other/Source: _____						
B11. Indicate elevation datum used for BFE in Item B9: <input type="checkbox"/> NGVD 1929 <input checked="" type="checkbox"/> NAVD 1988 <input type="checkbox"/> Other/Source: _____						
B12. Is the building located in a Coastal Barrier Resources System (CBRS) area or Otherwise Protected Area (OPA)? <input type="checkbox"/> Yes <input checked="" type="checkbox"/> No Designation Date: _____ <input type="checkbox"/> CBRS <input type="checkbox"/> OPA						

# ELEVATION CERTIFICATE

OMB No. 1660-0008  
Expiration Date: November 30, 2022

<b>IMPORTANT: In these spaces, copy the corresponding information from Section A.</b>			<b>FOR INSURANCE COMPANY USE</b>
Building Street Address (including Apt., Unit, Suite, and/or Bldg. No.) or P.O. Route and Box No. 2807 LEMON AVENUE			Policy Number:
City ENGLEWOOD	State Florida	ZIP Code 34223	Company NAIC Number

## SECTION C – BUILDING ELEVATION INFORMATION (SURVEY REQUIRED)

C1. Building elevations are based on:     Construction Drawings\*     Building Under Construction\*     Finished Construction

\*A new Elevation Certificate will be required when construction of the building is complete.

C2. Elevations – Zones A1–A30, AE, AH, A (with BFE), VE, V1–V30, V (with BFE), AR, AR/A, AR/AE, AR/A1–A30, AR/AH, AR/AO. Complete Items C2.a–h below according to the building diagram specified in Item A7. In Puerto Rico only, enter meters.

Benchmark Utilized: NGS BM SAR23    EL: 9.21'    Vertical Datum: NAVD1988

Indicate elevation datum used for the elevations in items a) through h) below.

NGVD 1929     NAVD 1988     Other/Source: \_\_\_\_\_

Datum used for building elevations must be the same as that used for the BFE.

Check the measurement used.

- |   |             |  |                                 |
|---|-------------|--|---------------------------------|
| a) Top of bottom floor (including basement, crawlspace, or enclosure floor)   | <u>5.8</u>  | <input checked="" type="checkbox"/> feet | <input type="checkbox"/> meters |
| b) Top of the next higher floor   | <u>18.3</u> | <input checked="" type="checkbox"/> feet | <input type="checkbox"/> meters |
| c) Bottom of the lowest horizontal structural member (V Zones only)   | <u>N/A</u>  | <input checked="" type="checkbox"/> feet | <input type="checkbox"/> meters |
| d) Attached garage (top of slab)  | <u>N/A</u>  | <input checked="" type="checkbox"/> feet | <input type="checkbox"/> meters |
| e) Lowest elevation of machinery or equipment servicing the building<br>(Describe type of equipment and location in Comments) | <u>12.6</u> | <input checked="" type="checkbox"/> feet | <input type="checkbox"/> meters |
| f) Lowest adjacent (finished) grade next to building (LAG)  | <u>5.0</u>  | <input checked="" type="checkbox"/> feet | <input type="checkbox"/> meters |
| g) Highest adjacent (finished) grade next to building (HAG)   | <u>5.7</u>  | <input checked="" type="checkbox"/> feet | <input type="checkbox"/> meters |
| h) Lowest adjacent grade at lowest elevation of deck or stairs, including structural support                                  | <u>5.0</u>  | <input checked="" type="checkbox"/> feet | <input type="checkbox"/> meters |

## SECTION D – SURVEYOR, ENGINEER, OR ARCHITECT CERTIFICATION

This certification is to be signed and sealed by a land surveyor, engineer, or architect authorized by law to certify elevation information. I certify that the information on this Certificate represents my best efforts to interpret the data available. I understand that any false statement may be punishable by fine or imprisonment under 18 U.S. Code, Section 1001.

Were latitude and longitude in Section A provided by a licensed land surveyor?     Yes     No     Check here if attachments.

Certifier's Name B. GREGORY RIETH	License Number 5228		
Title PSM/CFM			
Company Name STRAYER SURVEYING AND MAPPING, INC.			
Address 742 SHAMROCK BLVD			
City VENICE	State Florida		ZIP Code 34293
Signature 	Date 04-14-2021	Telephone (941) 497-1290	Ext.

Copy all pages of this Elevation Certificate and all attachments for (1) community official, (2) insurance agent/company, and (3) building owner.

Comments (including type of equipment and location, per C2(e), if applicable)  
FILE #19-01-85. THE A/C UNIT ON THE SOUTH SIDE OF THE HOME WAS USED FOR SECTION C2e. SECTION A5 WAS DERIVED FROM A HAND HELD G.P.S. UNIT (GPSTEST APP - NO CONVERSION). SUBJECT STRUCTURE HAS (11) FLOOD VENTS (MODEL #1540-520), ENGINEERED FOR 2,200 SQUARE FEET (TOTAL). ATTACHED IS ICC-ES EVALUATION REPORT ESR-2074.

DATE OF FIELD SURVEY: 04/01/2021

\* THIS ELEVATION CERTIFICATE IS ONLY VALID FOR THE PERSON(S) LISTED IN SECTION A1. \*

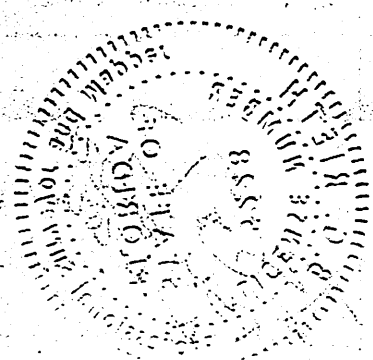

*[Handwritten signature]*

ҚАЗАҚСТАН РЕСПУБЛИКАСЫНЫҢ БІЛІМ ЖӘНЕ ҒЫЛЫМ МИНИСТРЛІГІ

# ELEVATION CERTIFICATE

OMB No. 1660-0008  
Expiration Date: November 30, 2022

<b>IMPORTANT: In these spaces, copy the corresponding information from Section A.</b>			<b>FOR INSURANCE COMPANY USE</b>
Building Street Address (including Apt., Unit, Suite, and/or Bldg. No.) or P.O. Route and Box No. 2807 LEMON AVENUE			Policy Number:
City ENGLEWOOD	State Florida	ZIP Code 34223	Company NAIC Number

## SECTION E – BUILDING ELEVATION INFORMATION (SURVEY NOT REQUIRED) FOR ZONE AO AND ZONE A (WITHOUT BFE)

For Zones AO and A (without BFE), complete Items E1–E5. If the Certificate is intended to support a LOMA or LOMR-F request, complete Sections A, B, and C. For Items E1–E4, use natural grade, if available. Check the measurement used. In Puerto Rico only, enter meters.

- E1. Provide elevation information for the following and check the appropriate boxes to show whether the elevation is above or below the highest adjacent grade (HAG) and the lowest adjacent grade (LAG).
- a) Top of bottom floor (including basement, crawlspace, or enclosure) is \_\_\_\_\_  feet  meters  above or  below the HAG.
- b) Top of bottom floor (including basement, crawlspace, or enclosure) is \_\_\_\_\_  feet  meters  above or  below the LAG.
- E2. For Building Diagrams 6–9 with permanent flood openings provided in Section A Items 8 and/or 9 (see pages 1–2 of Instructions), the next higher floor (elevation C2.b in the diagrams) of the building is \_\_\_\_\_  feet  meters  above or  below the HAG.
- E3. Attached garage (top of slab) is \_\_\_\_\_  feet  meters  above or  below the HAG.
- E4. Top of platform of machinery and/or equipment servicing the building is \_\_\_\_\_  feet  meters  above or  below the HAG.
- E5. Zone AO only: If no flood depth number is available, is the top of the bottom floor elevated in accordance with the community's floodplain management ordinance?  Yes  No  Unknown. The local official must certify this information in Section G.

## SECTION F – PROPERTY OWNER (OR OWNER'S REPRESENTATIVE) CERTIFICATION

The property owner or owner's authorized representative who completes Sections A, B, and E for Zone A (without a FEMA-issued or community-issued BFE) or Zone AO must sign here. The statements in Sections A, B, and E are correct to the best of my knowledge.

Property Owner or Owner's Authorized Representative's Name			
Address	City	State	ZIP Code
Signature	Date	Telephone	

Comments

Check here if attachments.

# ELEVATION CERTIFICATE

# BUILDING PHOTOGRAPHS

See Instructions for Item A6.

OMB No. 1660-0008

Expiration Date: November 30, 2022

<b>IMPORTANT: In these spaces, copy the corresponding information from Section A.</b>			<b>FOR INSURANCE COMPANY USE</b>
Building Street Address (including Apt., Unit, Suite, and/or Bldg. No.) or P.O. Route and Box No. 2807 LEMON AVENUE			Policy Number:
City ENGLEWOOD	State Florida	ZIP Code 34223	Company NAIC Number

If using the Elevation Certificate to obtain NFIP flood insurance, affix at least 2 building photographs below according to the instructions for Item A6. Identify all photographs with date taken; "Front View" and "Rear View"; and, if required, "Right Side View" and "Left Side View." When applicable, photographs must show the foundation with representative examples of the flood openings or vents, as indicated in Section A8. If submitting more photographs than will fit on this page, use the Continuation Page.



FRONT VIEW 04/01/2021

Photo One Caption

Clear Photo One



REAR VIEW 04/01/2021

Photo Two Caption

Clear Photo Two

**ELEVATION CERTIFICATE**

**BUILDING PHOTOGRAPHS**

Continuation Page

OMB No. 1660-0008  
Expiration Date: November 30, 2022

<b>IMPORTANT: In these spaces, copy the corresponding information from Section A.</b>			<b>FOR INSURANCE COMPANY USE</b>
Building Street Address (including Apt., Unit, Suite, and/or Bldg. No.) or P.O. Route and Box No. 2807 LEMON AVENUE			Policy Number:
City ENGLEWOOD	State Florida	ZIP Code 34223	Company NAIC Number

If submitting more photographs than will fit on the preceding page, affix the additional photographs below. Identify all photographs with: date taken; "Front View" and "Rear View"; and, if required, "Right Side View" and "Left Side View." When applicable, photographs must show the foundation with representative examples of the flood openings or vents, as indicated in Section A8.

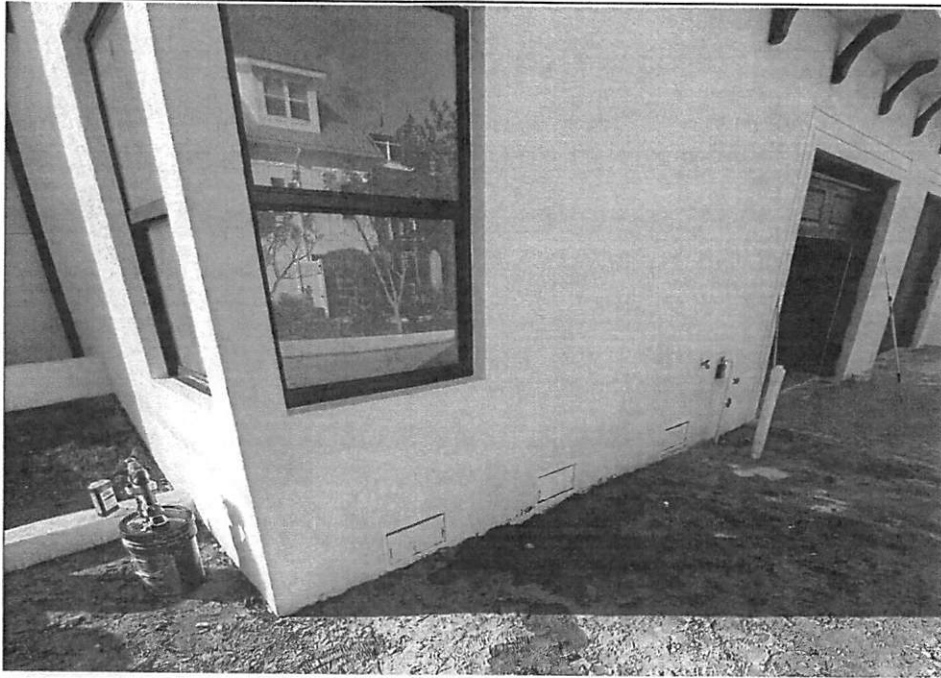

VENTS 04/01/2021

Photo Three Caption

Clear Photo Three

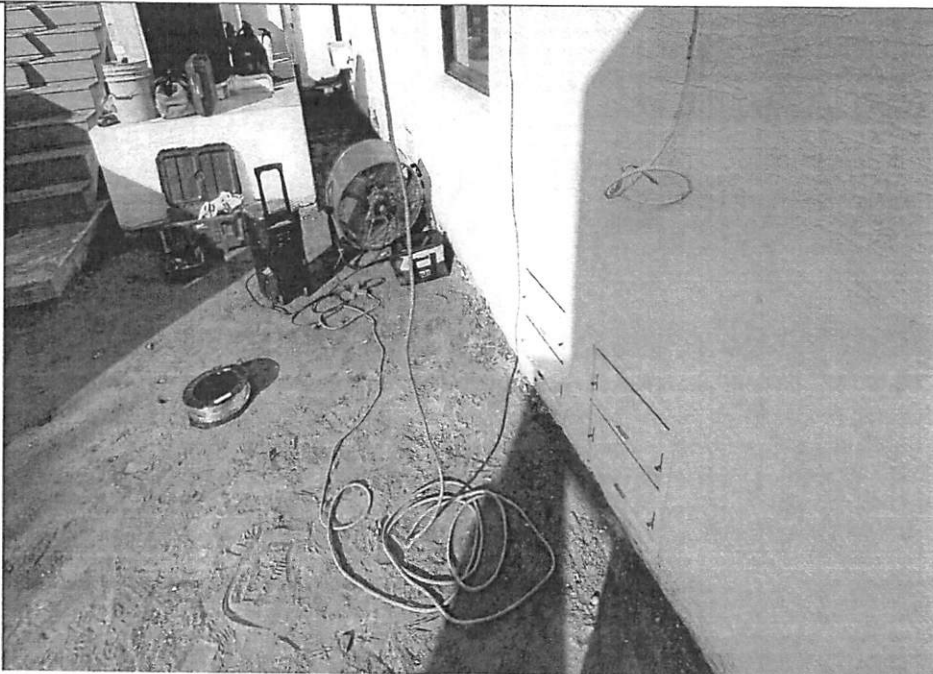

VENTS 04/01/2021

Photo Four Caption

Clear Photo Four



*Most Widely Accepted and Trusted*

# ICC-ES Evaluation Report

# ESR-2074

ICC-ES | (800) 423-6587 | (562) 699-0543 | www.icc-es.org

Reissued 02/2021  
This report is subject to renewal 02/2023.

**DIVISION: 08 00 00—OPENINGS**

**SECTION: 08 95 45— VENTS/FOUNDATION FLOOD VENTS**

**REPORT HOLDER:**

**SMART VENT PRODUCTS, INC.**

**EVALUATION SUBJECT:**

**SMART VENT® AUTOMATIC FOUNDATION FLOOD VENTS; MODELS #1540-520;  
#1540-521; #1540-510; #1540-511; #1540-570; #1540-574; #1540-524; #1540-514;  
FLOOD VENT SEALING KIT #1540-526**



*"2014 Recipient of Prestigious Western States Seismic Policy Council (WSSPC) Award in Excellence"*



*ICC-ES Evaluation Reports are not to be construed as representing aesthetics or any other attributes not specifically addressed, nor are they to be construed as an endorsement of the subject of the report or a recommendation for its use. There is no warranty by ICC Evaluation Service, LLC, express or implied, as to any finding or other matter in this report, or as to any product covered by the report.*



Copyright © 2021 ICC Evaluation Service, LLC. All rights reserved.



**DIVISION: 08 00 00—OPENINGS**  
**Section: 08 95 43—Vents/Foundation Flood Vents**

**REPORT HOLDER:**

**SMART VENT PRODUCTS, INC.**

**EVALUATION SUBJECT:**

**SMART VENT® AUTOMATIC FOUNDATION FLOOD VENTS: MODELS #1540-520; #1540-521; #1540-510; #1540-511; #1540-570; #1540-574; #1540-524; #1540-514 FLOOD VENT SEALING KIT #1540-526**

**1.0 EVALUATION SCOPE**

**Compliance with the following codes:**

- 2018, 2015, 2012, 2009 and 2006 *International Building Code*® (IBC)
- 2018, 2015, 2012, 2009 and 2006 *International Residential Code*® (IRC)
- 2018 *International Energy Conservation Code*® (IECC)
- 2013 *Abu Dhabi International Building Code* (ADIBC)†

†The ADIBC is based on the 2009 IBC. 2009 IBC code sections referenced in this report are the same sections in the ADIBC.

**Properties evaluated:**

- Physical operation
- Water flow

**2.0 USES**

The Smart Vent® units are engineered mechanically operated flood vents (FVs) employed to equalize hydrostatic pressure on walls of enclosures subject to rising or falling flood waters. Certain models also allow natural ventilation.

**3.0 DESCRIPTION**

**3.1 General:**

When subjected to rising water, the Smart Vent® FVs internal floats are activated, then pivot open to allow flow in either direction to equalize water level and hydrostatic pressure from one side of the foundation to the other. The FV pivoting door is normally held in the closed position by a buoyant release device. When subjected to rising water, the buoyant release device causes the unit to unlatch, allowing the door to rotate out of the way and allow flow. The water level stabilizes, equalizing the lateral forces.

Each unit is fabricated from stainless steel. Smart Vent® Automatic Foundation Flood Vents are available in various models and sizes as described in Table 1. The SmartVENT® Stacking Model #1540-511 and FloodVENT® Stacking Model #1540-521 units each contain two vertically arranged openings per unit.

**3.2 Engineered Opening:**

The FVs comply with the design principle noted in Section 2.7.2.2 and Section 2.7.3 of ASCE/SEI 24-14 [Section 2.6.2.2 of ASCE/SEI 24-05 (2012, 2009, 2006 IBC and IRC)] for a maximum rate of rise and fall of 5.0 feet per hour (0.423 mm/s). In order to comply with the engineered opening requirement of ASCE/SEI 24, Smart Vent FVs must be installed in accordance with Section 4.0.

**3.3 Ventilation:**

The SmartVENT® Model #1540-510 and SmartVENT® Overhead Door Model #1540-514 both have screen covers with 1/4-inch-by-1/4-inch (6.35 by 6.35 mm) openings, yielding 51 square inches (32 903 mm²) of net free area to supply natural ventilation. The SmartVENT® Stacking Model #1540-511 consists of two Model #1540-510 units in one assembly, and provides 102 square inches (65 806 mm²) of net free area to supply natural ventilation. Other FVs recognized in this report do not offer natural ventilation.

**3.4 Flood Vent Sealing Kit:**

The Flood Vent Sealing Kit Model #1540-526 is used with SmartVENT® Model #1540-520. It is a Homasote 440 Sound Barrier® (ESR-1374) insert with 21 – 2-inch-by-2-inch (51 mm x 51 mm) squares cut in it. See Figure 4.

**4.0 DESIGN AND INSTALLATION**

**4.1 SmartVENT® and FloodVENT®:**

SmartVENT® and FloodVENT® are designed to be installed into walls or overhead doors of existing or new construction from the exterior side. Installation of the vents must be in accordance with the manufacturer's instructions, the applicable code and this report. Installation clips allow mounting in masonry and concrete walls of any thickness. In order to comply with the engineered opening design principle noted in Section 2.7.2.2 and 2.7.3 of ASCE/SEI 24-14 [Section 2.6.2.2 of ASCE/SEI 24-05 (2012, 2009, 2006 IBC and IRC)], the Smart Vent® FVs must be installed as follows:

- With a minimum of two openings on different sides of each enclosed area.
- With a minimum of one FV for every 200 square

feet (18.6 m<sup>2</sup>) of enclosed area, except that the SmartVENT<sup>®</sup> Stacking Model #1540-511 and FloodVENT<sup>®</sup> Stacking Model #1540-521 must be installed with a minimum of one FV for every 400 square feet (37.2 m<sup>2</sup>) of enclosed area.

- Below the base flood elevation.
- With the bottom of the FV located a maximum of 12 inches (305.4 mm) above the higher of the final grade or floor and finished exterior grade immediately under each opening.

**4.2 Flood Vent Sealing Kit**

The Flood Vent Sealing Kit Model 1540-526 is used in conjunction with FloodVENT<sup>®</sup> Model #1540-520. When installed and tested in accordance with ASTM E283, the FV and Flood Vent Sealing Kit assembly have an air leakage rate of less than 0.2 cubic feet per minute per lineal foot (18.56 l/min per lineal meter) at a pressure differential of 1 pound per square foot (50 Pa) based on 12.58 lineal feet (3.8 lineal meters) contained by the Flood Vent Sealing Kit.

**5.0 CONDITIONS OF USE**

The Smart Vent<sup>®</sup> FVs described in this report comply with, or are suitable alternatives to what is specified in, those codes listed in Section 1.0 of this report, subject to the following conditions:

- 5.1 The Smart Vent<sup>®</sup> FVs must be installed in accordance with this report, the applicable code and the manufacturer's installation instructions. In the event of a conflict, the instructions in this report govern.

- 5.2 The Smart Vent<sup>®</sup> FVs must not be used in the place of "breakaway walls" in coastal high hazard areas, but are permitted for use in conjunction with breakaway walls in other areas.

**6.0 EVIDENCE SUBMITTED**

- 6.1 Data in accordance with the ICC-ES Acceptance Criteria for Mechanically Operated Flood Vents (AC364), dated August 2015 (editorially revised October 2017).
- 6.2 Test report on air infiltration in accordance with ASTM E283.

**7.0 IDENTIFICATION**

- 7.1 The Smart VENT<sup>®</sup> models and the Flood Vent Sealing Kit recognized in this report must be identified by a label bearing the manufacturer's name (Smartvent Products, Inc.), the model number, and the evaluation report number (ESR-2074).
- 7.2 The report holder's contact information is the following:

**SMART VENT PRODUCTS, INC.**  
**430 ANDBRO DRIVE, UNIT 1**  
**PITMAN, NEW JERSEY 08071**  
**(877) 441-8368**  
[www.smartvent.com](http://www.smartvent.com)  
[info@smartvent.com](mailto:info@smartvent.com)

TABLE 1—MODEL SIZES

MODEL NAME	MODEL NUMBER	MODEL SIZE (in.)	COVERAGE (sq. ft.)
FloodVENT <sup>®</sup>	1540-520	15 <sup>3</sup> / <sub>4</sub> " X 7 <sup>3</sup> / <sub>4</sub> "	200
SmartVENT <sup>®</sup>	1540-510	15 <sup>3</sup> / <sub>4</sub> " X 7 <sup>3</sup> / <sub>4</sub> "	200
FloodVENT <sup>®</sup> Overhead Door	1540-524	15 <sup>3</sup> / <sub>4</sub> " X 7 <sup>3</sup> / <sub>4</sub> "	200
SmartVENT <sup>®</sup> Overhead Door	1540-514	15 <sup>3</sup> / <sub>4</sub> " X 7 <sup>3</sup> / <sub>4</sub> "	200
Wood Wall FloodVENT <sup>®</sup>	1540-570	14" X 8 <sup>3</sup> / <sub>4</sub> "	200
Wood Wall FloodVENT <sup>®</sup> Overhead Door	1540-574	14" X 8 <sup>3</sup> / <sub>4</sub> "	200
SmartVENT <sup>®</sup> Stacker	1540-511	16" X 16"	400
FloodVent <sup>®</sup> Stacker	1540-521	16" X 16"	400

For SI: 1 inch = 25.4 mm; 1 square foot = m<sup>2</sup>

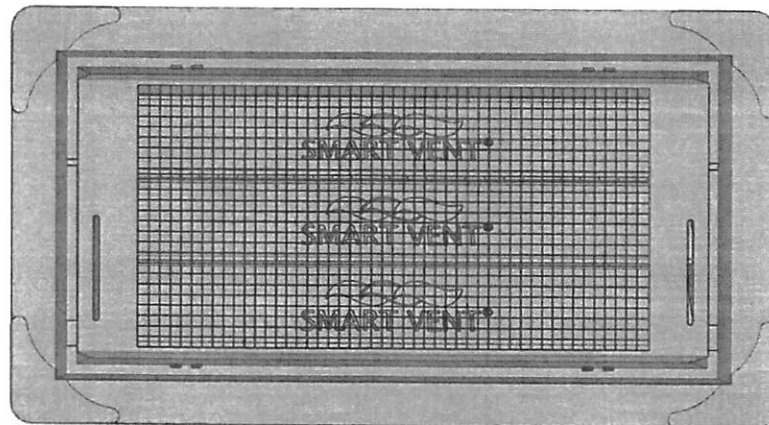

FIGURE 1—SMART VENT: MODEL 1540-510

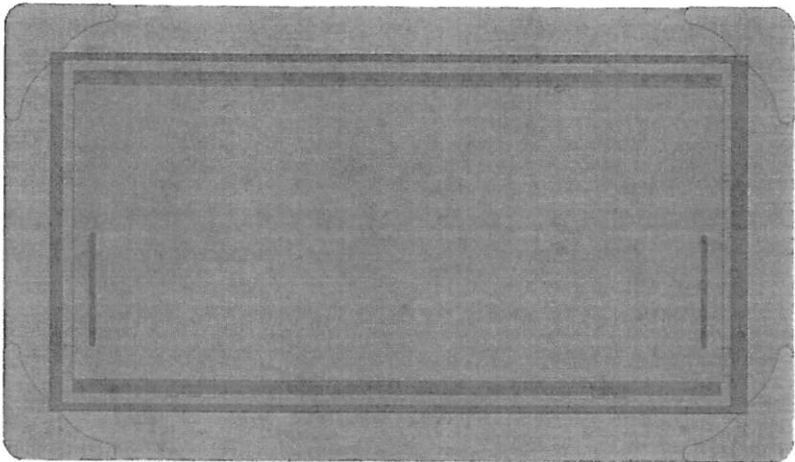

FIGURE 2—SMART VENT MODEL 1540-520

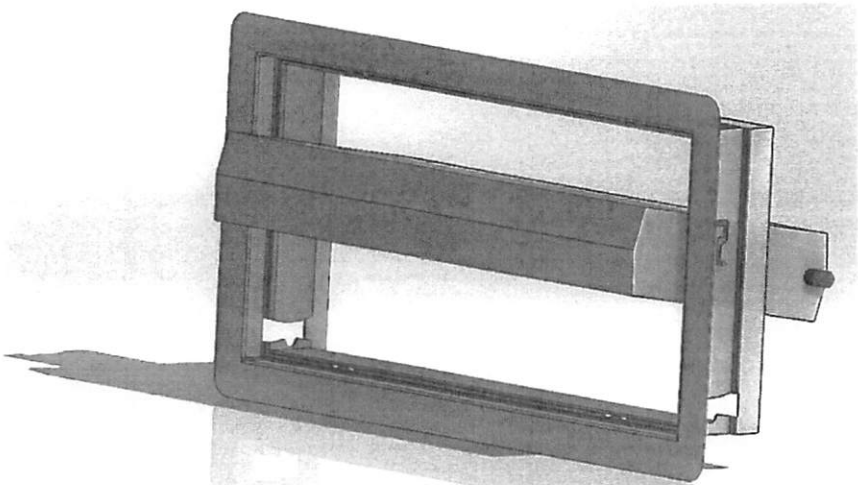

FIGURE 3—SMART VENT: SHOWN WITH FLOOD DOOR PIVOTED OPEN

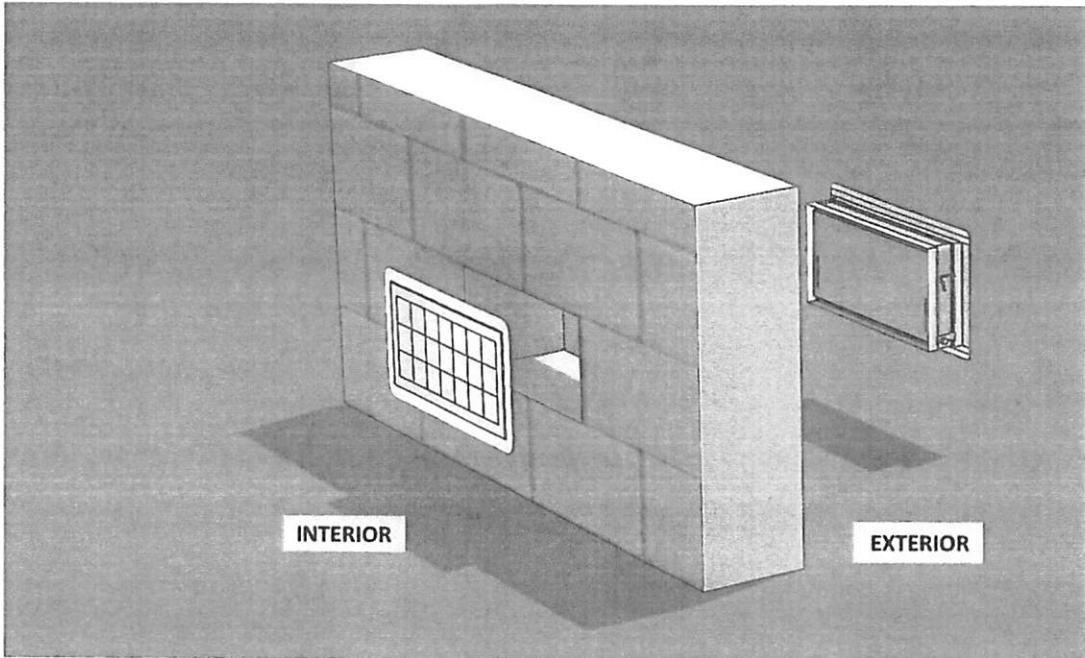

FIGURE 4—FLOOD VENT SEALING KIT

**DIVISION: 08 00 00—OPENINGS**

**Section: 08 95 43—Vents/Foundation Flood Vents**

**REPORT HOLDER:**

**SMART VENT PRODUCTS, INC.**

**EVALUATION SUBJECT:**

**SMART VENT® AUTOMATIC FOUNDATION FLOOD VENTS: MODELS #1540-520; #1540-521; #1540-510; #1540-511; #1540-570; #1540-574; #1540-524; #1540-514  
FLOOD VENT SEALING KIT #1540-526**

## 1.0 REPORT PURPOSE AND SCOPE

### Purpose:

The purpose of this evaluation report supplement is to indicate that Smart Vent® Automatic Foundation Flood Vents, described in ICC-ES evaluation report ESR-2074, have also been evaluated for compliance with codes noted below.

### Applicable code edition:

- 2016 *California Building Code* (CBC)
- 2016 *California Residential Code* (CRC)

## 2.0 CONCLUSIONS

### 2.1 CBC:

The Smart Vent® Automatic Foundation Flood Vents, described in Sections 2.0 through 7.0 of the evaluation report ESR-2074, comply with 2016 CBC Chapter 12, provided the design and installation are in accordance with the 2015 *International Building Code*® (IBC) provisions noted in the evaluation report and the additional requirements of CBC Chapters 12, 16 and 16A, as applicable.

### 2.2 CRC:

The Smart Vent® Automatic Foundation Flood Vents, described in Sections 2.0 through 7.0 of the evaluation report ESR-2074, comply with the 2016 CRC, provided the design and installation are in accordance with the 2015 *International Residential Code*® (IRC) provisions noted in the evaluation report.

This supplement expires concurrently with the evaluation report, reissued February 2021.

DIVISION: 08 00 00—OPENINGS  
Section: 08 95 43—Vents/Foundation Flood Vents

**REPORT HOLDER:**

SMART VENT PRODUCTS, INC.

**EVALUATION SUBJECT:**

SMART VENT® AUTOMATIC FOUNDATION FLOOD VENTS: MODELS #1540-520; #1540-521; #1540-510; #1540-511; #1540-570; #1540-574; #1540-524; #1540-514  
FLOOD VENT SEALING KIT #1540-526

## 1.0 REPORT PURPOSE AND SCOPE

**Purpose:**

The purpose of this evaluation report supplement is to indicate that Smart Vent® Automatic Foundation Flood Vents, described in ICC-ES evaluation report ESR-2074, have also been evaluated for compliance with the codes noted below.

**Applicable code editions:**

- 2017 Florida Building Code—Building
- 2017 Florida Building Code—Residential

## 2.0 CONCLUSIONS

The Smart Vent® Automatic Foundation Flood Vents, described in Sections 2.0 through 7.0 of the evaluation report ESR-2074, comply with the *Florida Building Code—Building* and the FRC, provided the design and installation are in accordance with the 2015 *International Building Code*® provisions noted in the evaluation report.

Use of the Smart Vent® Automatic Foundation Flood Vents has also been found to be in compliance with the High-Velocity Hurricane Zone provisions of the *Florida Building Code—Building* and the *Florida Building Code—Residential*.

For products falling under Florida Rule 9N-3, verification that the report holder's quality assurance program is audited by a quality assurance entity approved by the Florida Building Commission for the type of inspections being conducted is the responsibility of an approved validation entity (or the code official when the report holder does not possess an approval by the Commission).

This supplement expires concurrently with the evaluation report, reissued February 2021.