

ELEVATION CERTIFICATE

OMB No. 1660-0008
Expiration Date: November 30, 2022

IMPORTANT: In these spaces, copy the corresponding information from Section A.			FOR INSURANCE COMPANY USE
Building Street Address (including Apt., Unit, Suite, and/or Bldg. No.) or P.O. Route and Box No. 345 O DAY DRIVE			Policy Number:
City ENGLEWOOD	State Florida	ZIP Code 34223	Company NAIC Number

SECTION G – COMMUNITY INFORMATION (OPTIONAL)

The local official who is authorized by law or ordinance to administer the community's floodplain management ordinance can complete Sections A, B, C (or E), and G of this Elevation Certificate. Complete the applicable item(s) and sign below. Check the measurement used in Items G8–G10. In Puerto Rico only, enter meters.

- G1. The information in Section C was taken from other documentation that has been signed and sealed by a licensed surveyor, engineer, or architect who is authorized by law to certify elevation information. (Indicate the source and date of the elevation data in the Comments area below.)
- G2. A community official completed Section E for a building located in Zone A (without a FEMA-issued or community-issued BFE) or Zone AO.
- G3. The following information (Items G4–G10) is provided for community floodplain management purposes.

G4. Permit Number 20-175754 B1	G5. Date Permit Issued	G6. Date Certificate of Compliance/Occupancy Issued
--	------------------------	---

- G7. This permit has been issued for: New Construction Substantial Improvement
- G8. Elevation of as-built lowest floor (including basement) of the building: _____ feet meters Datum _____
- G9. BFE or (in Zone AO) depth of flooding at the building site: _____ feet meters Datum _____
- G10. Community's design flood elevation: _____ feet meters Datum _____

Local Official's Name	Title
Community Name	Telephone
Signature	Date

Comments (including type of equipment and location, per C2(e), if applicable)

Check here if attachments.

ELEVATION CERTIFICATE

Form No. 1300-01-01
Revised: November 2013

PART B: In these spaces copy the corresponding information from Section A	
Building Street Address (including Apt. Unit, Suite and/or Box) and P.O. Box and Zip Code	3450 DAY DRIVE
City	INGLEWOOD
State	Illinois
ZIP Code	60438
Company NAIC Number	
FOR INSURANCE COMPANY USE	Policy Number

SECTION G - COMMUNITY INFORMATION (OPTIONAL)

The local official who is authorized by law or ordinance to administer the community's floodplain management or ordinance can complete Sections A, B, C, E, and G of the Elevation Certificate. Complete the applicable items and sign below. Check if a measurement is used in items G8-G10. In Puerto Rico only use the metric data in the Comments area below.

- G1. The information in Section C was taken from one or more elevation certificates that have been signed and sealed by a licensed engineer or architect who is authorized by law to certify elevation information (indicate the source and date of the elevation data in the Comments area below).
- G2. A community official completed Section E for a building located in Zone A (where a FEMA-issued or community-issued permit or Zone AO).
- G3. The following information (item G4-G10) is provided for community floodplain management purposes:

G4. Permit Number	G5. Date Permit Issued	G6. Date Certificate Issued	G7. Company/Community Level
20-1234567			

- G8. This point has been measured New Construction Elevation Improvement
- G9. Elevation of pre-built lowest floor (including basement) feet meters
- G10. Community's design flood elevation: feet meters
- G11. BFE or (in Zone AO) depth of flooding at the building elevation: feet meters

Local Official's Name	Signature
Community Name	Date
Telephone	

Comments (indicate type of equipment and location for G10, if applicable)

Check here if off-street

ELEVATION CERTIFICATE

Important: Follow the instructions on pages 1-9.

Copy all pages of this Elevation Certificate and all attachments for (1) community official, (2) insurance agent/company, and (3) building owner.

SECTION A – PROPERTY INFORMATION				FOR INSURANCE COMPANY USE	
A1. Building Owner's Name ROBERT & SARAH GETTER				Policy Number:	
A2. Building Street Address (including Apt., Unit, Suite, and/or Bldg. No.) or P.O. Route and Box No. 345 O DAY DRIVE				Company NAIC Number:	
City ENGLEWOOD		State Florida		ZIP Code 34223	
A3. Property Description (Lot and Block Numbers, Tax Parcel Number, Legal Description, etc.) METES AND BOUNDS, PID#0503150035					
A4. Building Use (e.g., Residential, Non-Residential, Addition, Accessory, etc.) <u>RESIDENTIAL</u>					
A5. Latitude/Longitude: Lat. <u>276.955968</u> Long. <u>(-)82.360509</u> Horizontal Datum: <input type="checkbox"/> NAD 1927 <input checked="" type="checkbox"/> NAD 1983					
A6. Attach at least 2 photographs of the building if the Certificate is being used to obtain flood insurance.					
A7. Building Diagram Number <u>1B</u>					
A8. For a building with a crawlspace or enclosure(s):					
a) Square footage of crawlspace or enclosure(s) <u>N/A</u> sq ft					
b) Number of permanent flood openings in the crawlspace or enclosure(s) within 1.0 foot above adjacent grade <u>N/A</u>					
c) Total net area of flood openings in A8.b <u>N/A</u> sq in					
d) Engineered flood openings? <input type="checkbox"/> Yes <input checked="" type="checkbox"/> No					
A9. For a building with an attached garage:					
a) Square footage of attached garage <u>809.00</u> sq ft					
b) Number of permanent flood openings in the attached garage within 1.0 foot above adjacent grade <u>5</u>					
c) Total net area of flood openings in A9.b <u>1000.00</u> sq in					
d) Engineered flood openings? <input checked="" type="checkbox"/> Yes <input type="checkbox"/> No					
SECTION B – FLOOD INSURANCE RATE MAP (FIRM) INFORMATION					
B1. NFIP Community Name & Community Number SARASOTA COUNTY, FLORIDA 125144			B2. County Name SARASOTA		B3. State Florida
B4. Map/Panel Number 12115C0453	B5. Suffix F	B6. FIRM Index Date 11-04-2016	B7. FIRM Panel Effective/ Revised Date 11-04-2016	B8. Flood Zone(s) AE	B9. Base Flood Elevation(s) (Zone AO, use Base Flood Depth) 12
B10. Indicate the source of the Base Flood Elevation (BFE) data or base flood depth entered in Item B9: <input type="checkbox"/> FIS Profile <input type="checkbox"/> FIRM <input type="checkbox"/> Community Determined <input checked="" type="checkbox"/> Other/Source: <u>LOMR EFFECTIVE MARCH 12, 2021</u>					
B11. Indicate elevation datum used for BFE in Item B9: <input type="checkbox"/> NGVD 1929 <input checked="" type="checkbox"/> NAVD 1988 <input type="checkbox"/> Other/Source: _____					
B12. Is the building located in a Coastal Barrier Resources System (CBRS) area or Otherwise Protected Area (OPA)? <input type="checkbox"/> Yes <input checked="" type="checkbox"/> No Designation Date: _____ <input type="checkbox"/> CBRS <input type="checkbox"/> OPA					

ELEVATION CERTIFICATE

OMB No. 1660-0008
Expiration Date: November 30, 2022

IMPORTANT: In these spaces, copy the corresponding information from Section A.			FOR INSURANCE COMPANY USE
Building Street Address (including Apt., Unit, Suite, and/or Bldg. No.) or P.O. Route and Box No. 345 O DAY DRIVE			Policy Number:
City ENGLEWOOD	State Florida	ZIP Code 34223	Company NAIC Number

SECTION C – BUILDING ELEVATION INFORMATION (SURVEY REQUIRED)

C1. Building elevations are based on: Construction Drawings* Building Under Construction* Finished Construction

*A new Elevation Certificate will be required when construction of the building is complete.

C2. Elevations – Zones A1–A30, AE, AH, A (with BFE), VE, V1–V30, V (with BFE), AR, AR/A, AR/AE, AR/A1–A30, AR/AH, AR/AO. Complete Items C2.a–h below according to the building diagram specified in Item A7. In Puerto Rico only, enter meters.

Benchmark Utilized: NGS DATAPOINT P635 Vertical Datum: NAVD 1988

Indicate elevation datum used for the elevations in items a) through h) below.

NGVD 1929 NAVD 1988 Other/Source: _____

Datum used for building elevations must be the same as that used for the BFE.

Check the measurement used.

- | | | | |
|---|-------------|--|---------------------------------|
| a) Top of bottom floor (including basement, crawlspace, or enclosure floor) | <u>13.2</u> | <input checked="" type="checkbox"/> feet | <input type="checkbox"/> meters |
| b) Top of the next higher floor | <u>19.2</u> | <input checked="" type="checkbox"/> feet | <input type="checkbox"/> meters |
| c) Bottom of the lowest horizontal structural member (V Zones only) | <u>N/A</u> | <input checked="" type="checkbox"/> feet | <input type="checkbox"/> meters |
| d) Attached garage (top of slab) | <u>6.2</u> | <input checked="" type="checkbox"/> feet | <input type="checkbox"/> meters |
| e) Lowest elevation of machinery or equipment servicing the building
(Describe type of equipment and location in Comments) | <u>13.1</u> | <input checked="" type="checkbox"/> feet | <input type="checkbox"/> meters |
| f) Lowest adjacent (finished) grade next to building (LAG) | <u>5.0</u> | <input checked="" type="checkbox"/> feet | <input type="checkbox"/> meters |
| g) Highest adjacent (finished) grade next to building (HAG) | <u>5.8</u> | <input checked="" type="checkbox"/> feet | <input type="checkbox"/> meters |
| h) Lowest adjacent grade at lowest elevation of deck or stairs, including structural support | <u>5.0</u> | <input checked="" type="checkbox"/> feet | <input type="checkbox"/> meters |

SECTION D – SURVEYOR, ENGINEER, OR ARCHITECT CERTIFICATION

This certification is to be signed and sealed by a land surveyor, engineer, or architect authorized by law to certify elevation information. I certify that the information on this Certificate represents my best efforts to interpret the data available. I understand that any false statement may be punishable by fine or imprisonment under 18 U.S. Code, Section 1001.

Were latitude and longitude in Section A provided by a licensed land surveyor? Yes No Check here if attachments.

Certifier's Name
JAMES B. AMBERGER

License Number
LS6333

Title
PRESIDENT

Company Name
JIM AMBERGER LAND SURVEYING LLC

Address
1055 S. TAMiami TRAIL, SUITE 110-B

City
SARASOTA

State
Florida

ZIP Code
34236

Signature  Date 5/2/2022 Telephone (941) 955-6333 Ext.

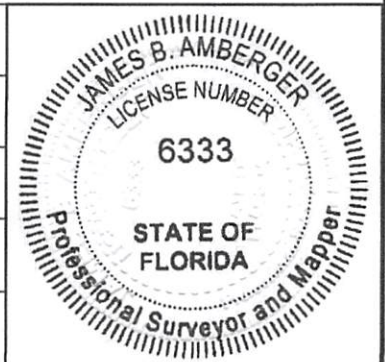

Copy all pages of this Elevation Certificate and all attachments for (1) community official, (2) insurance agent/company, and (3) building owner.

Comments (including type of equipment and location, per C2(e), if applicable)

B8/B9/B10: LOMR EFFECTIVE MARCH 12, 2021, CASE #20-04-5135P

C2e: AIR CONDITIONING COMPRESSOR LOCATED ON EASTERLY SIDE OF RESIDENCE

C2a/c2f: THE DIFFERENCE BETWEEN THESE ELEVATIONS IS DUE TO THIS BEING BACKFILLED STEMWALL CONSTRUCTION.

A9(a/d): FLOOD FLAP MODEL FFWF12. THESE VENTS ARE RATED TO PROVIDE SUFFICIENT HYDROSTATIC PRESSURE FOR 220 SQUARE FEET EACH

550 FORMS FEEL EACH

VS (AND) GOOD FEEL MODEL FORMS. THESE FORMS ARE DESIGNED TO PROVIDE SUFFICIENT INFORMATION FOR YOU TO ASSESS THE RELATIONSHIP BETWEEN THESE EVALUATIONS AND TO THIS BEING SUFFICIENT EVIDENCE FOR...
CONSTRUCTION (including the of information and records for CS(6) if applicable)

Only all pages of the elevation drawings and/or photographs (if applicable) must be submitted with this (3) required cover

Form with fields for Signature, Date, Title, and Organization. Includes a circular seal on the right side.

Does this project and/or activity is subject to regulation by a local or state agency? Yes No
Does this project and/or activity is subject to regulation by the of the Department under 16 CFR 1200.1000? Yes No

SECTION 9 - SUBLEASES, LICENSURE OR TECHNICAL ASSISTANCE

Table with 3 columns: Description, Amount, and Yes/No checkboxes. Rows include items like 'Professional services', 'Construction services', etc.

Do you need for additional evaluations from the state or local level for this project? Yes No

Indicate evaluation dates for the elevations in items 9) through 11) below

Contract number: 1000-01-0001-0001 / amount: \$1,000,000.00
CS Evaluation - under 16 CFR 1200.1000 (16 CFR 1200.1000) (16 CFR 1200.1000) (16 CFR 1200.1000)
A new evaluation (contract) will be required upon completion of the project to complete

SECTION 10 - BUILDING ELEVATION INFORMATION (IF APPLICABLE)

Form with fields for Elevation Code, Date, Title, and Organization. Includes a section for 'ELEVATION DESCRIPTION'.

ELEVATION CERTIFICATE

OMB No. 1660-0008
Expiration Date: November 30, 2022

IMPORTANT: In these spaces, copy the corresponding information from Section A.			FOR INSURANCE COMPANY USE
Building Street Address (including Apt., Unit, Suite, and/or Bldg. No.) or P.O. Route and Box No. 345 O DAY DRIVE			Policy Number:
City ENGLEWOOD	State Florida	ZIP Code 34223	Company NAIC Number

SECTION E – BUILDING ELEVATION INFORMATION (SURVEY NOT REQUIRED) FOR ZONE AO AND ZONE A (WITHOUT BFE)

For Zones AO and A (without BFE), complete Items E1–E5. If the Certificate is intended to support a LOMA or LOMR-F request, complete Sections A, B, and C. For Items E1–E4, use natural grade, if available. Check the measurement used. In Puerto Rico only, enter meters.

- E1. Provide elevation information for the following and check the appropriate boxes to show whether the elevation is above or below the highest adjacent grade (HAG) and the lowest adjacent grade (LAG).
- a) Top of bottom floor (including basement, crawlspace, or enclosure) is _____ feet meters above or below the HAG.
- b) Top of bottom floor (including basement, crawlspace, or enclosure) is _____ feet meters above or below the LAG.
- E2. For Building Diagrams 6–9 with permanent flood openings provided in Section A Items 8 and/or 9 (see pages 1–2 of Instructions), the next higher floor (elevation C2.b in the diagrams) of the building is _____ feet meters above or below the HAG.
- E3. Attached garage (top of slab) is _____ feet meters above or below the HAG.
- E4. Top of platform of machinery and/or equipment servicing the building is _____ feet meters above or below the HAG.
- E5. Zone AO only: If no flood depth number is available, is the top of the bottom floor elevated in accordance with the community's floodplain management ordinance? Yes No Unknown. The local official must certify this information in Section G.

SECTION F – PROPERTY OWNER (OR OWNER'S REPRESENTATIVE) CERTIFICATION

The property owner or owner's authorized representative who completes Sections A, B, and E for Zone A (without a FEMA-issued or community-issued BFE) or Zone AO must sign here. The statements in Sections A, B, and E are correct to the best of my knowledge.

Property Owner or Owner's Authorized Representative's Name

Address _____ City _____ State _____ ZIP Code _____

Signature _____ Date _____ Telephone _____

Comments

Check here if attachments.

BUILDING PHOTOGRAPHS

See Instructions for Item A6.

OMB No. 1660-0008

Expiration Date: November 30, 2022

ELEVATION CERTIFICATE

IMPORTANT: In these spaces, copy the corresponding information from Section A.

FOR INSURANCE COMPANY USE

Building Street Address (including Apt., Unit, Suite, and/or Bldg. No.) or P.O. Route and Box No.
345 O DAY DRIVE

Policy Number:

City State ZIP Code
ENGLEWOOD Florida 34223

Company NAIC Number

If using the Elevation Certificate to obtain NFIP flood insurance, affix at least 2 building photographs below according to the instructions for Item A6. Identify all photographs with date taken; "Front View" and "Rear View"; and, if required, "Right Side View" and "Left Side View." When applicable, photographs must show the foundation with representative examples of the flood openings or vents, as indicated in Section A8. If submitting more photographs than will fit on this page, use the Continuation Page.



Photo One

Photo One Caption FRONT VIEW

Clear Photo One



Photo Two

Photo Two Caption REAR VIEW

Clear Photo Two

BUILDING PHOTOGRAPHS

ELEVATION CERTIFICATE

Continuation Page

OMB No. 1660-0008
Expiration Date: November 30, 2022

IMPORTANT: In these spaces, copy the corresponding information from Section A.			FOR INSURANCE COMPANY USE
Building Street Address (including Apt., Unit, Suite, and/or Bldg. No.) or P.O. Route and Box No. 345 O DAY DRIVE			Policy Number:
City ENGLEWOOD	State Florida	ZIP Code 34223	Company NAIC Number

If submitting more photographs than will fit on the preceding page, affix the additional photographs below. Identify all photographs with: date taken; "Front View" and "Rear View"; and, if required, "Right Side View" and "Left Side View." When applicable, photographs must show the foundation with representative examples of the flood openings or vents, as indicated in Section A8.



Photo Three

Photo Three Caption TYPICAL FLOW-THRU VENT FLOOD FLAP MODEL FFWF12

Clear Photo Three

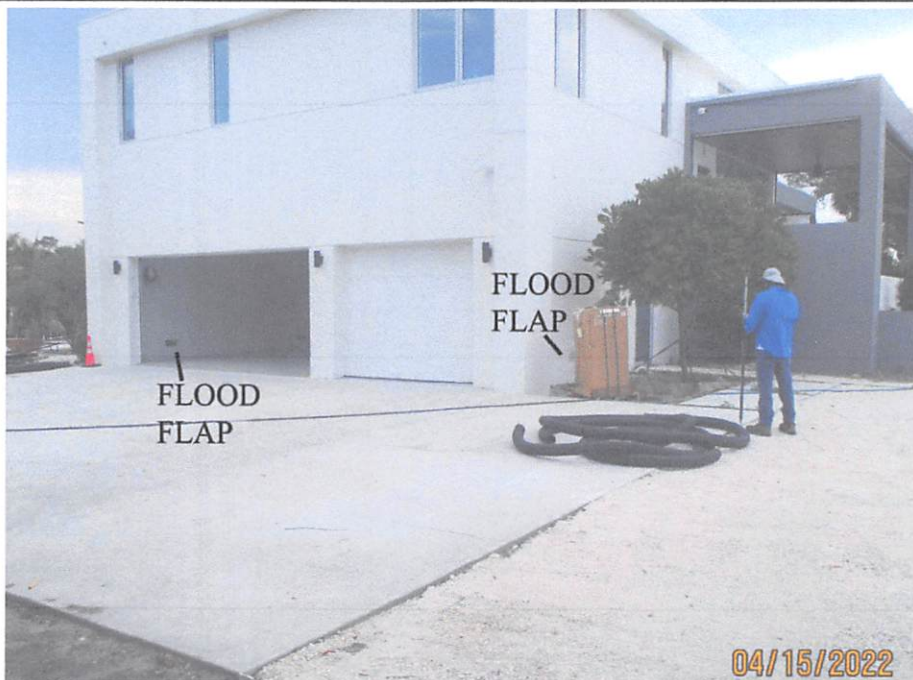

Photo Four

Photo Four Caption SIDE VIEW SHOWING FLOOD FLAPS LOCATED ON OPPOSITE WALLS OF GARAGE

Clear Photo Four

DIVISION: 08 00 00—OPENINGS

Section: 08 95 43—Vents/Foundation Flood Vents

REPORT HOLDER:

FLOOD FLAPS®, LLC

EVALUATION SUBJECT:

FLOOD FLAPS® AUTOMATIC FLOOD VENTS: MODELS FFWF12; FFNF12; FFWF08; FFNF08; FFWF05; FFNF05

1.0 REPORT PURPOSE AND SCOPE

Purpose:

The purpose of this evaluation report supplement is to indicate that Flood Flaps® automatic flood vents, described in ICC-ES evaluation report ESR-3560, have also been evaluated for compliance with the codes noted below.

Applicable code editions:

- 2017 *Florida Building Code—Building*
- 2017 *Florida Building Code—Residential*

2.0 CONCLUSIONS

The Flood Flaps flood vents, described in Sections 2.0 through 7.0 of the evaluation report ESR-3560, comply with the *Florida Building Code—Building* and the *Florida Building Code—Residential*, provided the design and installation are in accordance with the 2015 *International Building Code*® provisions noted in the evaluation report.

Use of the Flood Flaps flood vents has also been found to be in compliance with the High-Velocity Hurricane Zone provisions of the *Florida Building Code—Building* and the *Florida Building Code—Residential*.

For products falling under Florida Rule 9N-3, verification that the report holder's quality-assurance program is audited by a quality-assurance entity approved by the Florida Building Commission for the type of inspections being conducted is the responsibility of an approved validation entity (or the code official, when the report holder does not possess an approval by the Commission).

This supplement expires concurrently with the evaluation report, reissued September 2020.

DIVISION: 08 00 88—OPENINGS

Section: 08 95 43—Vents/Foundation Flood Vents

REPORT HOLDER:

FLOOD FLAPS®, LLC

EVALUATION SUBJECT:

FLOOD FLAPS® AUTOMATIC FLOOD VENTS: MODELS FFWF12; FFNF12; FFWF08; FFNF08; FFWF05; FFNF05

1.0 REPORT PURPOSE AND SCOPE

Purpose:

The purpose of this evaluation report supplement is to indicate that Flood Flaps® automatic flood vents, described in ICC-ES evaluation report [ESR-3560](#), has also been evaluated for compliance with the code(s) noted below.

Applicable code edition(s):

- 2019 California Building Code (CBC)
- 2019 California Residential Code (CRC)

For evaluation of applicable chapters adopted by the California Office of Statewide Health Planning and Development (OSHPD) and Division of State Architect (DSA), see Sections 2.1.1 and 2.1.2 below.

2.0 CONCLUSIONS

2.1 CBC:

The Flood Flaps® automatic flood vents, described in Sections 2.0 through 7.0 of the evaluation report [ESR-3560](#), comply with CBC Chapter 12, provided the design and installation are in accordance with the 2018 *International Building Code*® (IBC) provisions noted in the evaluation report and the additional requirements of CBC Chapters 12 and 16, as applicable.

2.1.1 OSHPD: The applicable OSHPD Sections of the CBC are beyond the scope of this supplement.

2.1.2 DSA: The applicable DSA Sections of the CBC are beyond the scope of this supplement.

2.2 CRC:

The Flood Flaps® automatic flood vents, described in Sections 2.0 through 7.0 of the evaluation report ESR-3560, comply with 2019 CRC, provided the design and installation are in accordance with the 2018 *International Residential Code*® (IRC) provisions noted in the evaluation report.

This supplement expires concurrently with the evaluation report reissued September 2020.

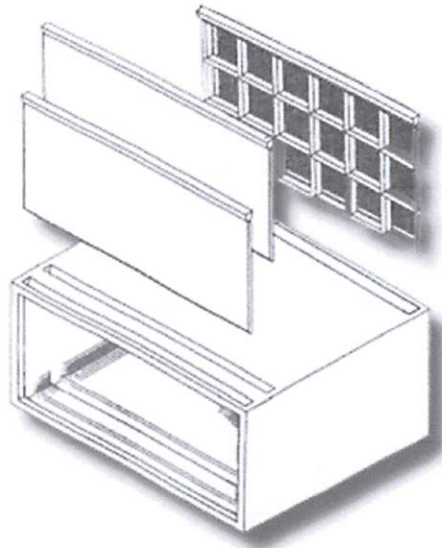
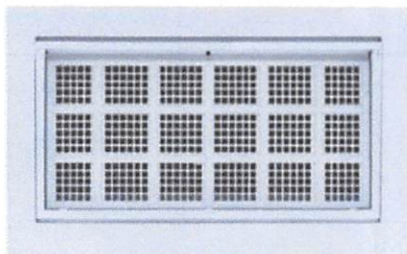
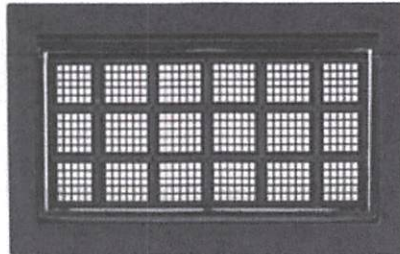

FIGURE 1—FLOOD FLAPS® AUTOMATIC FLOOD VENT



FFWF12



FFNF08

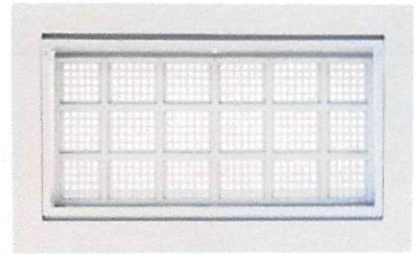

FFNF05

FIGURE 2—FLOOD FLAPS® AUTOMATIC FLOOD VENT SERIES MODELS

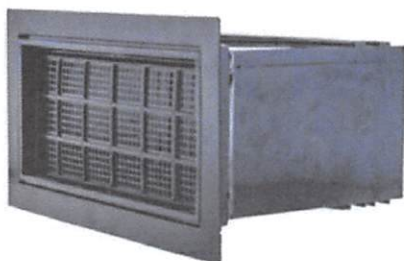

12" DEPTH

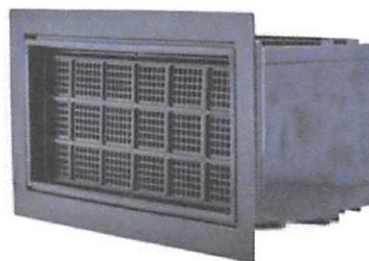

8" DEPTH



5" DEPTH

FIGURE 3—FLOOD FLAPS® AUTOMATIC FLOOD VENTS MULTIPLE DEPTH OFFERINGS

- Below the base flood elevation.
- With the bottom of the FV located a maximum of 12 inches (305 mm) above grade.

5.0 CONDITIONS OF USE

The Flood Flaps® automatic flood vents described in this report comply with, or are suitable alternatives to what is specified in, those codes listed in Section 1.0 of this report, subject to the following conditions:

- 5.1 The Flood Flaps® automatic FVs must be installed in accordance with this report, the applicable code and the manufacturer’s installation instructions. In the event of a conflict, the instructions in this report govern.
- 5.2 The Flood Flaps® automatic FVs must not be used in place of “breakaway walls” in coastal high hazard areas, but are permitted for use in conjunction with breakaway walls in other areas.

6.0 EVIDENCE SUBMITTED

Data in accordance with the ICC-ES Acceptance Criteria for Mechanically Operated Flood Vents (AC364), dated August 2015 (editorially revised October 2017).

7.0 IDENTIFICATION

7.1 The Flood Flaps® models recognized in this report are identified by a label bearing the manufacturer’s name, the model number, and the evaluation report number (ESR-3560).

7.2 The report holder’s contact information is the following:

FLOOD FLAPS®, LLC
POST OFFICE BOX 1003
ISLE OF PALMS, SOUTH CAROLINA 29451
(843) 881-0190
www.floodflaps.com
info@floodflaps.com

TABLE 1—FLOOD FLAP AUTOMATIC FLOOD VENT MODEL SIZES

MODEL NUMBER	MODEL DESIGNATION	ROUGH OPENING (Width X Height) (inches)	VENT SIZE (W X H X D) (inches)	ENCLOSED AREA COVERAGE (ft²)	NET FREE AREA OPENING¹ (in²)
FFWF12	Sealed Series	16 x 8	15 ⁵ / ₈ X 7 ³ / ₄ X 12	220	NA
FFNF12	Multi-Purpose	16 x 8	15 ⁵ / ₈ X 7 ³ / ₄ X 12	220	37
FFWF08	Sealed Series	16 x 8	15 ⁵ / ₈ X 7 ³ / ₄ X 8	220	NA
FFNF08	Multi-Purpose	16 x 8	15 ⁵ / ₈ X 7 ³ / ₄ X 8	220	37
FFWF05	Sealed Series	16 x 8	15 ⁵ / ₈ X 7 ³ / ₄ X 5	220	NA
FFNF05	Multi-Purpose	16 x 8	15 ⁵ / ₈ X 7 ³ / ₄ X 5	220	37

For SI: 1 inch = 25.4 mm; 1 ft² = 0.093 m²

¹For under-floor ventilation only.

DIVISION: 08 00 00—OPENINGS
Section: 08 95 43—Vents/Foundation Flood Vents

REPORT HOLDER:

FLOOD FLAPS®, LLC

EVALUATION SUBJECT:

FLOOD FLAPS® AUTOMATIC FLOOD VENTS: MODELS
 FFWF12; FFNF12; FFWF08; FFNF08; FFWF05; FFNF05

1.0 EVALUATION SCOPE

Compliance with the following codes:

- 2018, 2015, 2012 and 2009 *International Building Code*® (IBC)
- 2018, 2015, 2012 and 2009 *International Residential Code*® (IRC)

Properties evaluated:

- Physical operation
- Water flow
- Weathering

2.0 USES

Flood Flaps® automatic flood vents are used to provide for the equalization of hydrostatic flood forces on exterior walls. Certain models also allow natural ventilation.

3.0 DESCRIPTION

3.1 General:

Flood Flaps® automatic flood vents are engineered mechanically operated flood vents (FVs) that automatically allow flood waters to enter and exit enclosed areas. The FVs are constructed of ABS plastic which serves as the FV's housing, and a front grill that contains an anodized metal screen imbedded in polypropylene plastic. On contact with rising flood water, the grill will disengage from its secured position, allowing flood water and debris to flow through in either direction. The FVs are available in two series as described in Section 3.3.

The sealed series models contain two rubber flaps that close the FV to the passage of air when using with conditioned areas or sealed crawl spaces. In the same manner as the grill, the two rubber flaps are pushed open

by water pressure, allowing water and debris to flow through the FV in either direction. See Figure 1 for an illustration of the Flood Flaps® automatic FV.

3.2 Engineered Opening:

The Flood Flaps® automatic FVs comply with the design principle noted in Sections 2.7.2.2 and 2.7.3 of ASCE/SEI 24-14 (2018 and 2015 IBC and IRC) [Section 2.6.2.2 of ASCE/SEI 24-05 (2012 and 2009 IBC and IRC)] for a rate of rise and fall of 5 feet per hour (0.423 mm/s). In order to comply with the engineered opening requirement of ASCE/SEI 24, Flood Flaps® automatic FVs must be installed in accordance with Section 4.0.

3.3 Flood Vent Series Models:

Flood Flaps® automatic FVs are available in two series with multiple models and sizes as described in Table 1. The sealed series models, designated FFWF, include two rubber flaps for the prevention of air flow. The multi-purpose series, designated FFNF, omits the rubber flaps.

3.4 Natural Ventilation:

Flood Flaps® automatic FV models FFNF12, FFNF08, FFNF05, and FFNF02 have metal screens with 1/4 inch by 1/4 inch (6 mm by 6 mm) openings and provide 37 square inches (0.02 m²) of net free opening to supply natural ventilation for under-floor ventilation. Flood Flaps® automatic FV models FFWF12, FFWF08, and FFWF05 have not been evaluated for use as openings for under-floor ventilation.

4.0 DESIGN AND INSTALLATION

Flood Flaps® automatic FVs are designed to be installed into walls of existing or new construction. Installation of the FVs must be in accordance with the manufacturer's instructions, the applicable code and this report. Flood Flaps® automatic FVs can be installed in wood, masonry and concrete walls up to a thickness of 12 inches (305 mm). In order to comply with the engineered opening design principle noted in Sections 2.7.2.2 and 2.7.3 of ASCE/SEI 24-14 (2018 and 2015 IBC and IRC) [Section 2.6.2.2 of ASCE/SEI 24-05 (2012 and 2009 IBC and IRC)], the Flood Flaps® FVs must be installed as follows:

- With a minimum of two openings on different sides of each enclosed area.
- With a minimum of one FV for every 220 square feet (20 m²) of enclosed area.